

KATAI

CATÁLOGO 2022



PRODUCTO HECHO EN MÉXICO
CERTIFICACIÓN ISO 9001:2015
AVANZADA TECNOLOGÍA ALEMANA



Confianza en el camino

Nosotros

Como resultado de la adquisición de la empresa MC Heavy Duty por el grupo de inversionistas de ZOR Capital Group, nace **KATAI Industries** una empresa totalmente reestructurada, con maquinaria de la última generación, procesos de manufactura modernos y eficientes que aseguran la máxima calidad en sus productos, hechos con materia prima de las más alta calidad y recurso humano calificado.

KATAI Industries fusiona lo mejor de ambas empresas, la experiencia de 70 años de MC Heavy Duty en la producción de todo tipo de muelles para sus-

presión; y la experiencia y el conocimiento del mercado de autopartes de ZOR Capital Group.

Nos especializamos en la fabricación de todo tipo de muelles, como multi-hojas, muelles parabólicas y zetas, con los más altos estándares de calidad, por esta razón atendemos tanto el mercado original como el de repuesto.

KATAI es una de las empresas líderes en México en la fabricación de todo tipo de muelles. Con el crecimiento constante, materia prima de alta calidad y tecnología alemana, garantizamos nuestros procesos de calidad.

ÍNDICE / Fabricante

NOSOTROS.....	1
INSTRUCCIONES PARA MEDIR MUELLES.....	6
TIPOS DE ACABADO EN PUNTAS O EXTREMOS DE HOJAS.....	7
AUTOCAR.....	8
CHRYSLER.....	8-14
DINA.....	15-22
FAMSA.....	22-24
FORD.....	24-43
FREIGHTLINER.....	43-50
FRUEHAUF.....	51-53
GM.....	53-65
HENDRICKSON.....	66-68
HUTCHENS.....	69-73
INDUSTRIAS GONZÁLEZ.....	73-73
INTERNATIONAL.....	74-77
ISUZU.....	77-78
KENWORTH.....	78-84
MACK.....	84-87
MASA.....	87-88
MERCEDES.....	89-94
MUELLES PARA REMOLQUE LIGERO.....	94-96
NAVISTAR.....	96-101
NEWAY.....	102-102
NISSAN.....	102-106
OISA CONDOR.....	107-107
PETERBILT.....	107-110
RAMÍREZ.....	110-110
RASTRAS AGRÍCOLAS.....	111-111
REYCO.....	112-117
TANDEM.....	117-119
TOYOTA.....	119-122
TRAILMOBILE.....	123-123
VOLKSWAGEN.....	124-125
VOLVO.....	125-127
WATSON & CHALIN.....	127-127
WHITE.....	128-128
BUJES.....	129-130
BUJES METAL.....	131-131
OTROS.....	132-134

ÍNDICE / Número de parte

KA70-105-P.....	8	KA55-053.....	24	KA43-498.....	37
KA34-1451.....	8	KA44-120.....	24	KA43-490.....	37
KA34-1305.....	8	KA43-1679.....	25	KA43-478.....	37
KA34-931D-P.....	9	KA43-1291.....	25	KA43-487-P.....	38
KA34-931C-P.....	9	KA43-1289.....	25	KA43-415.....	38
KA34-931A.....	10	KA43-1279.....	26	KA43-404.....	39
KAH-100D.....	10	KA43-1263.....	26	KA43-390.....	39
KA34-780.....	10	KA43-1261.....	26	KA43-388.....	39
KA34-582-P.....	11	KA43-1199.....	26	KA43-386.....	40
KA34-582A.....	11	KA43-1117.....	27	KA43-377.....	40
KA34-227B.....	11	KA43-1085.....	27	KA43-358A-P.....	40
KA34-227A.....	12	KA43-1071.....	27	KA43-358.....	41
KA34-227.....	12	KA43-1041.....	28	KA43-349.....	41
KA34-045.....	12	KA43-1003.....	28	KA43-347-P.....	42
KA34-931DA.....	13	KA43-967.....	28	KA43-293.....	42
KA34-043.....	13	KA43-899-P.....	29	KA43-195.....	42
KA34-017A.....	13	KA43-899A.....	29	KA43-185.....	43
KA33-340C.....	14	KA43-863.....	29	KA13-C340.....	43
KA34-4020.....	14	KA43-883-P.....	30	KA43-2016T.....	43
KA80-280-P.....	15	KA43-818A-P.....	30	KA48-887.....	44
KA71-125-P145/8.....	16	KA43-818.....	30	KA46-1464.....	44
KA71-125A-P.....	16	KA43-816.....	31	KA46-1462.....	44
KA70-116.....	17	KA43-812.....	31	KA46-1432-P.....	45
KA70-113.....	17	KA43-803.....	31	KA46-1418.....	45
KA55-1206-P.....	17	KA43-781A-P.....	32	KA46-1309.....	45
KA55-1206A.....	18	KA43-781.....	32	KA46-1406-P.....	46
KA55-958-P3.....	18	KA43-723.....	32	KA46-1319.....	46
KA55-928.....	18	KA43-711.....	33	KA46-1307.....	46
KA55-862.....	19	KA43-701-P.....	33	KA46-1302-P.....	47
KA55-564.....	19	KA43-698.....	33	KA46-1280.....	47
KA55-150.....	20	KA43-695.....	34	KA46-1246-P.....	47
KA55-118.....	20	KA43-694.....	34	KA46-1242.....	48
KA50-299.....	21	KA43-689.....	34	KA46-1217.....	48
KA50-179.....	21	KA43-682.....	35	KA46-1197.....	48
KA55-1219ST.....	22	KA43-623.....	35	KA46-1189.....	49
KA55-3012.....	22	KA43-611.....	35	KA46-220-P.....	49
KA55-158.....	22	KA43-571.....	36	KA59-824FL.....	49
KA55-834.....	23	KA43-559.....	36	KA39-626.....	50
KA55-154-10H.....	23	KA43-516.....	36	KA46-151-P.....	50

ÍNDICE / Número de parte

KA39-626A.....	50	KA22-403-P.....	64	KA55-1195.....	77
KA71-145C-P.....	51	KA22-403D.....	64	KA44-100E.....	77
KATRA-2172.....	51	KA22-402.....	64	KA56-450T.....	77
KATRA-699.....	52	KA22-338.....	65	KA56-300T.....	77
KATRA-697.....	52	KA22-336.....	65	KA56-190.....	78
KATRA-693.....	52	KA22-315.....	65	KA83-301.....	78
KATRA-086.....	53	KA50-403.....	66	KA71-157A.....	78
KATRA-081.....	53	KA50-389.....	66	KA71-157.....	79
KATRA-020.....	53	KA50-387.....	66	KA70-138-P.....	79
KA48-921.....	53	KA50-317-P.....	67	KA59-466A.....	80
KA39-029.....	54	KA50-301.....	67	KA59-466.....	80
KA22-1531.....	54	KA50-291.....	68	KA59-450.....	80
KA22-1289.....	54	KA50-275.....	68	KA59-428B.....	81
KA22-1271.....	55	KA50-267.....	68	KA59-428.....	81
KA22-1269.....	55	KATRA-2757.....	69	KA59-408.....	81
KA22-909.....	55	KATRA-2754.....	69	KA59-402.....	82
KA22-905.....	56	KATRA-2752.....	69	KA59-400.....	82
KA22-851.....	56	KATRA-2750.....	69	KA59-270-P7.....	82
KA22-845.....	56	KATRA-2728.....	70	KA59-231.....	83
KA22-837.....	57	KATRA-2727.....	70	KAST-800.....	83
KA22-835.....	57	KATRA-2726.....	70	KA59-610.....	83
KA22-809.....	57	KATRA-2727HD.....	71	KA71-157B5/8.....	84
KA22-807.....	58	KATRA-2741.....	71	KA71-157B3/4.....	84
KA22-801.....	58	KATRA-2740.....	71	KA83-257A.....	84
KA22-797-P.....	58	KATRA-2726HD.....	72	KA62-968.....	84
KA22-797A-P.....	59	KATRA-2705.....	72	KA70-183-P9.....	85
KA22-795.....	59	KATRA-2260.....	72	KA62-1044.....	85
KA22-793.....	59	KATRA-023.....	73	KA62-890.....	85
KA22-687.....	60	KATRA-021.....	73	KA62-858.....	86
KA22-547.....	60	KA71-156.....	73	KA62-856.....	86
KA22-531.....	60	KA55-1332.....	74	KA62-832.....	86
KA22-492.....	61	KA55-1238.....	74	KA62-830.....	87
KA22-490.....	61	KA55-1218.....	74	KA62-808.....	87
KA22-484.....	61	KA55-1180.....	75	KA71-167C.....	87
KA22-482.....	62	KA55-1176.....	75	KA71-167.....	88
KA22-480.....	62	KA55-1133.....	75	KA70-146.....	88
KA22-440.....	62	KA55-846-P.....	75	KA96-234-P.....	89
KA22-417-P.....	63	KA55-898-P.....	76	KA96-234A.....	89
KA22-417C.....	63	KA55-144.....	76	KA80-280A.....	90
KA22-417B.....	63	KA55-122.....	76	KA65-121.....	90

ÍNDICE / Número de parte

KA45-100A.....	91	KA69-111.....	106	KA71-175A.....	119
KA44-100D-P.....	91	KA69-2017.....	106	KA90-299.....	119
KA44-100C.....	92	KA69-1114.....	106	KA90-203.....	119
KA65-002.....	92	KA64-1001.....	107	KA90-201.....	120
KA80-280C-P15.....	93	KA23-510.....	107	KA90-173.....	120
KA65-121.....	93	KA75-220.....	107	KA90-171.....	120
KA65-1305.....	94	KA75-212.....	108	KA90-153A.....	120
KA36021417-P6.....	94	KA75-210.....	108	KA90-1491.....	121
KASW-P6.....	95	KA75-178.....	108	KA90-1371.....	121
KASW-P5.....	95	KA75-176.....	108	KA90-1171.....	121
KASW-P4.....	96	KA75-170.....	109	KA90-159.....	122
KAUNA-265.....	96	KA75-163.....	109	KA90-2009.....	122
KA55-1242.....	96	KA75-160.....	109	KA90-297.....	122
KA55-1217.....	97	KA75-132.....	110	KA71-204-P.....	123
KA55-1197.....	97	KA75-125.....	110	KATRA-1492.....	123
KA55-1195.....	97	KA70-151.....	110	KATRA-051.....	123
KA55-1192.....	98	KAAR-38906A.....	111	KA90-210.....	124
KA55-944.....	98	KAAR-38906.....	111	KA90-200.....	124
KA55-894.....	99	KAAR-36400.....	111	KA99-310.....	124
KA55-160.....	99	KA83-273.....	112	KA33-028.....	125
KA55-148-P.....	99	KA83-257.....	112	KA96-1308.....	125
KA55-041.....	100	KA83-127.....	112	KA96-1219.....	125
KA55-037.....	100	KATRA-3384.....	112	KA96-952.....	126
KA55-035.....	100	KA83-115.....	113	KA96-898.....	126
KA55-031.....	100	KATRA-3387.....	113	KA96-840.....	126
KA55-029.....	101	KATRA-3372.....	114	KA96-184-P.....	126
KA55-021-P.....	101	KATRA-3341.....	114	KA96-150A.....	127
KATRA-3223.....	101	KATRA-3340.....	114	KA96-150A.....	127
KATRA-3222.....	102	KATRA-3309.....	115	KATRA-3508.....	127
KA80-180H.....	102	KATRA-2297.....	115	KA96-1261.....	128
KA80-180G.....	102	KATRA-2270.....	115	KA96-103.....	128
KA80-180E.....	103	KATRA-2256.....	116	KA70-182.....	128
KA80-180D.....	103	KATRA-075.....	116		
KA80-180.....	103	KATRA-074.....	116		
KA80-140.....	104	KATRA-031.....	117		
KA69-2011T.....	104	KA71-198A-13H.....	117		
KA69-277.....	104	KA71-191B-P.....	118		
KA69-257.....	105	KA71-191A.....	118		
KA69-255.....	105	KA71-191.....	118		
KA69-251.....	105	KA71-175-P.....	119		







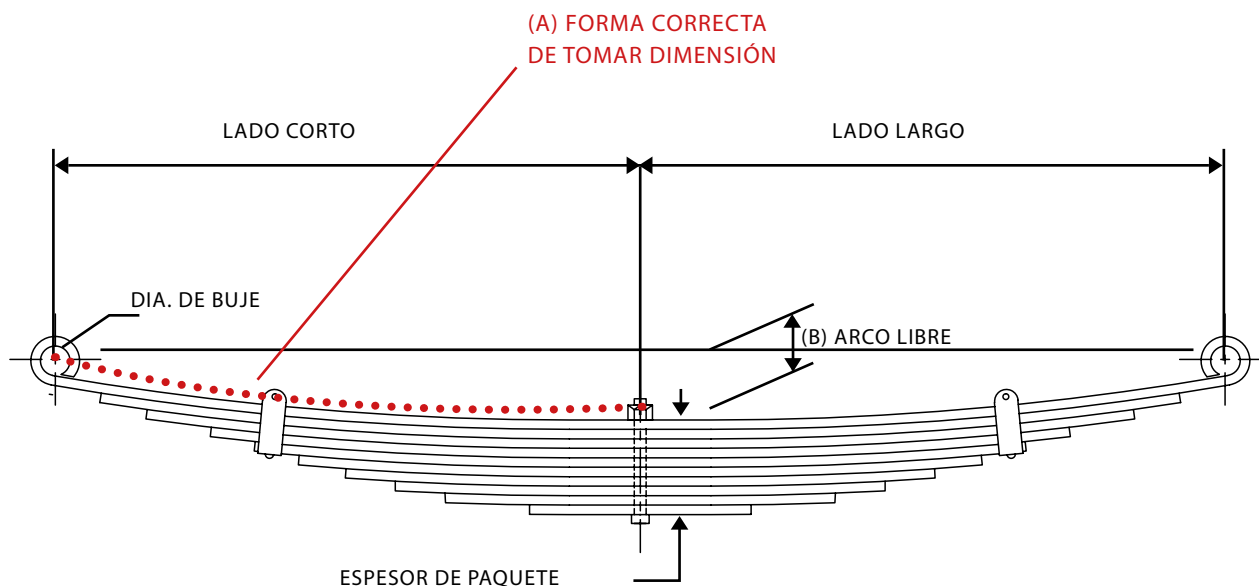



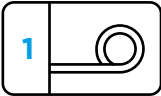

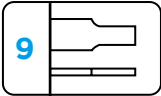
INSTRUCCIONES PARA MEDIR MUELLES

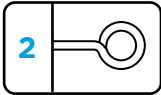
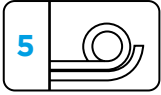
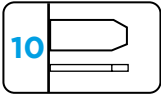
1. Las longitudes de lado corto y lado largo son tomadas estando en su forma plana, para ésto se tomará desde el tornillo de centro hacia el centro de roleo o final de extremo, a lo largo de la cara de la hoja como lo indica la línea punteada en la descripción (A).
2. Para medir la altura o el arco libre de la muelle, se tomarán como referencia los centros de roleos o extremos, trazando una línea de centro a centro de roleo o extremo a extremo y se mide desde la cara de la hoja, hasta la línea trazada, como lo indica la descripción (B).
3. Otro dato importante, es el ancho y espesor de las hojas o del paquete.

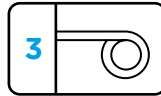
Nota: Las dimensiones en este catálogo están principalmente en pulgadas, las dimensiones en milímetros se les anexa al sufijo (mm) según sea el caso.

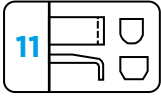

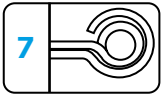
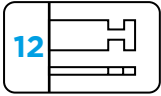
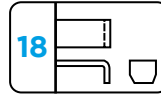
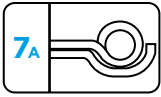
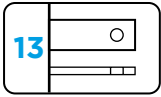
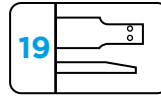
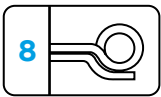
TIPOS DE ACABADO EN PUNTA O EXTREMOS DE HOJAS

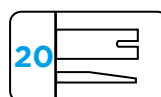
ROLEOS	ENVOLVENTES	HOJA LISA	DESPALMADOS	ESTÁNDAR
 <p>1</p> <p>ROLEO NORMAL</p>	 <p>4</p> <p>ENVOLVENTE NORMAL</p>	 <p>9</p> <p>DESTAJE</p>	 <p>15</p> <p>DESPALME REDONDO</p>	 <p>21</p> <p>CUADRADO LISO</p>
 <p>2</p> <p>ROLEO BERLIN</p>	 <p>5</p> <p>ENVOLVENTE 1/4</p>	 <p>10</p> <p>ACABADO DIAMANTE</p>	 <p>16</p> <p>DESPALME CUADRADO</p>	
 <p>3</p> <p>ROLEO INVERTIDO</p>	 <p>6</p> <p>ENVOLVENTE 1/4 INVERTIDO</p>	 <p>11</p> <p>ESCUADRA REDONDA</p>	 <p>17</p> <p>DESPALME CUADRADO C/PERF.</p>	
	 <p>7</p> <p>ENVOLVENTE BERLIN</p>	 <p>12</p> <p>ACABADO TIPO MACK</p>	 <p>18</p> <p>ESCUADRA C/DESPUNTE</p>	
	 <p>7A</p> <p>ENVOLVENTE 1/4 BERLIN</p>	 <p>13</p> <p>PERFORACIÓN EXTREMO</p>	 <p>19</p> <p>CUADRADO C/2PERFORACIONES</p>	
	 <p>8</p> <p>ENVOLVENTE PATA DE CHIVO</p>	 <p>14</p> <p>ACABADO TIPO VOLVO/WHITE</p>	 <p>20</p> <p>CUADRADO CON RANURA</p>	

KA70-105-P

AUTOCAR

Muelle Delantera

- Aplicación: Tracto Delantero #Original: 101892
- Modelo: 78-79 #Rassini: 70-105

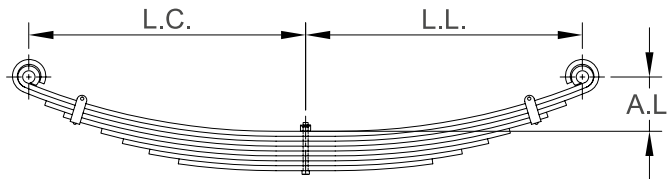

ANCHO	# HOJAS	CALIBRE	ARCO LIBRE	LONGITUD LADO CORTO	LONGITUD LADO LARGO	BUJE LADO CORTO	BUJE LADO LARGO	PUNTA LADO CORTO	PUNTA LADO LARGO
4	8 / .401	.401	5 3/4	25	25	NJK	NJK	 1	1 
	1A	.401	5 3/4	25	25	NJK	NJK	 1	1 
	2A	.401	5 3/4	25	25	-	-	 4	4 

KA34-1451

CHRYSLER

Muelle Trasera

- Aplicación: Dodge 1500 Rear Spring #Original: 52113141AD
- Modelo: 02-08
- Capacidad: 1715 lb

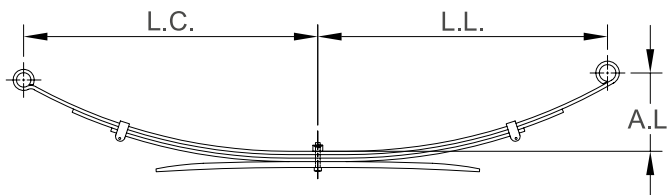

ANCHO	# HOJAS	CALIBRE	ARCO LIBRE	LONGITUD LADO CORTO	LONGITUD LADO LARGO	BUJE LADO CORTO	BUJE LADO LARGO	PUNTA LADO CORTO	PUNTA LADO LARGO
2 1/2	4 / .380,.360,.662	-	7 1/2	31 1/4	32	RB231	RB172	 2	1 

KA34-1305

CHRYSLER

Muelle Trasera

- Aplicación: Ram 3500 #Original: 52037755
- Modelo: 94 #Rassini: 33C-480-B
- Capacidad: 2828 lb

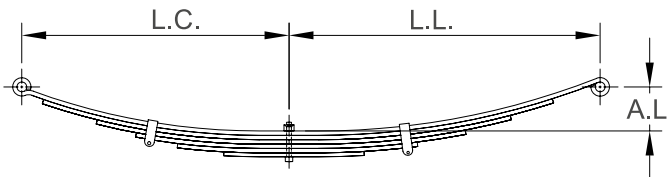

ANCHO	# HOJAS	CALIBRE	ARCO LIBRE	LONGITUD LADO CORTO	LONGITUD LADO LARGO	BUJE LADO CORTO	BUJE LADO LARGO	PUNTA LADO CORTO	PUNTA LADO LARGO
3	6 / .447	.447	4 1/2	27 7/8	32 1/8	15/8	15/8	 2	3 
	1A	.447	4 1/2	27 7/8	32 1/8	15/8	15/8	 2	3 
	2R	.447	4 1/2	27 7/8	30	-	-	 7A	10 

KA34-931D-P

CHRYSLER

Muelle Trasera

- Aplicación: Dodge RAM 4000
- Modelo: 05-08
- Capacidad: 8000 lb

#Original: 5271520-AB
#Rassini: 33C-560-C

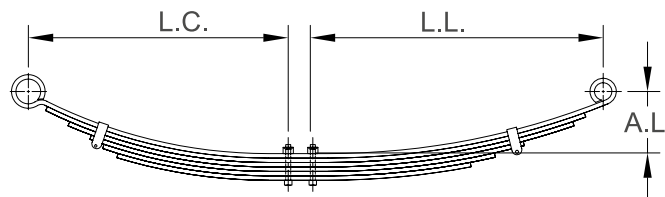

ANCHO	# HOJAS	CALIBRE	ARCO LIBRE	LONGITUD LADO CORTO	LONGITUD LADO LARGO	BUJE LADO CORTO	BUJE LADO LARGO	PUNTA LADO CORTO	PUNTA LADO LARGO
3	8 / .499	-	6 3/4	30 1/2	30 1/2	-	-	 2	1 
	1AUX	-	5	17	17	-	-	 21	21 
	1A	.499	6 3/4	30 1/2	30 1/2	-	-	 2	1 
	2A	.499	6 3/4	27 5/8	27 5/8	-	-	 10	10 
	2R	.499	6 3/4	30 1/8	31	-	-	 7A	10 
	3A	.499	6 3/4	23	23	-	-	 13	13 
	3R	.499	6 3/4	25	25	-	-	 10	10 
	4A	.499	6 3/4	18	18	-	-	 10	10 

KA34-931C-P

CHRYSLER

Muelle Trasera

- Aplicación: RAM 3500
- Modelo: 93-94

#Original: 52039228
#Rassini: 33C-480-C

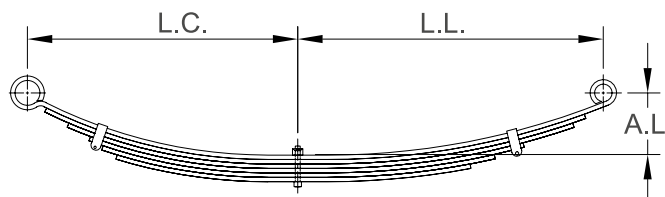

ANCHO	# HOJAS	CALIBRE	ARCO LIBRE	LONGITUD LADO CORTO	LONGITUD LADO LARGO	BUJE LADO CORTO	BUJE LADO LARGO	PUNTA LADO CORTO	PUNTA LADO LARGO
3	6 / .447	-	6 1/2	28 1/4	31 3/4	2 1/2	1 3/4	 2	1 
	1A	.447	6 1/2	28 1/4	31 3/4	2 1/2	1 3/4	 2	1 
	2A	.447	6 1/2	25 1/4	29 1/2	-	-	 10	10 
	2R	.447	6 1/2	28 1/4	31 3/4	-	-	 7A	10 
	3A	.447	6 1/2	23 3/4	28 1/4	-	-	 10	10 
	4A	.499	6 1/2	20	23	-	-	 13	10 
	5A	.499	6 1/2	17 3/4	20	-	-	 10	13 









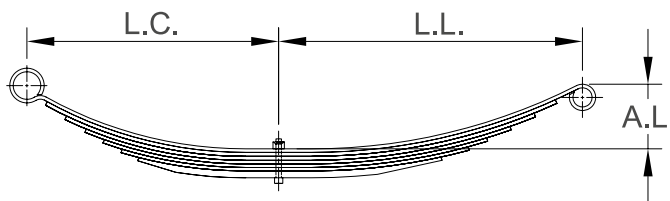

KA34-931A

CHRYSLER

Muelle Trasera

- Aplicación: D300 Doble Rodada
 - Modelo: 72-73
 - Capacidad: 3250 lb
- #Original: 3638190
#Rassini: 33C-400A



ANCHO	# HOJAS	CALIBRE	ARCO LIBRE	LONGITUD LADO CORTO	LONGITUD LADO LARGO	BUJE LADO CORTO	BUJE LADO LARGO	PUNTA LADO CORTO	PUNTA LADO LARGO
2 1/2	7 / .360	.360	3 1/2	24	28	RB-72	RB-72	 2	3 
	1A	.360	3 1/2	24	28	RB-72	RB-72	 2	3 
	2A	.360	3 1/2	22	26 1/4	-	-	 10	10 
	2R	.360	3 1/2	26 1/8	26 3/8	-	-	 7A	10 
	3A	.360	3 1/2	20	23 7/8	-	-	 10	10 





KAH-100D

CHRYSLER

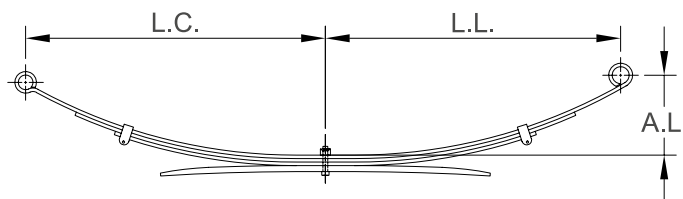
Muelle Trasera

- Aplicación: Chrysler H-100
 - Modelo: 06
- #Rassini: 33C-580-D



ANCHO	# HOJAS	CALIBRE	ARCO LIBRE	LONGITUD LADO CORTO	LONGITUD LADO LARGO	BUJE LADO CORTO	BUJE LADO LARGO	PUNTA LADO CORTO	PUNTA LADO LARGO
60 MM	2 / 60 MM X 9MM	9 MM	4 1/2	20 1/8	26 7/8	13/16	1 1/8	 1	1 
	1A	9 MM	4 1/2	20 1/8	26 7/8	13/16	1 1/8	 1	1 

KA34-780





CHRYSLER

Muelle Delantera

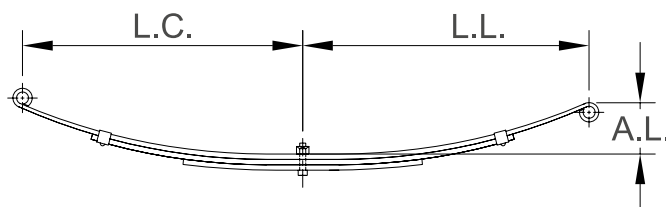
- Aplicación: Camioneta Dodge Del 24 X 24
- Modelo: 86-91
- Capacidad: 1400 lb

#Original: 4228415 #Rassini: 32C-280-B



ANCHO	# HOJAS	CALIBRE	ARCO LIBRE	LONGITUD LADO CORTO	LONGITUD LADO LARGO	BUJE LADO CORTO	BUJE LADO LARGO	PUNTA LADO CORTO	PUNTA LADO LARGO
2 1/2	3 / .447	.447	2	24	24	RB57	RB57	 1	3 
	1A	.447	2	24	24	RB57	RB57	 1	3 

KA34-582-P

CHRYSLER

Muelle Delantera

- Aplicación: D500-D600 #Original: 3732825
- Modelo: 74-83 #Rassini: 32-220
- Capacidad: 5400 lb

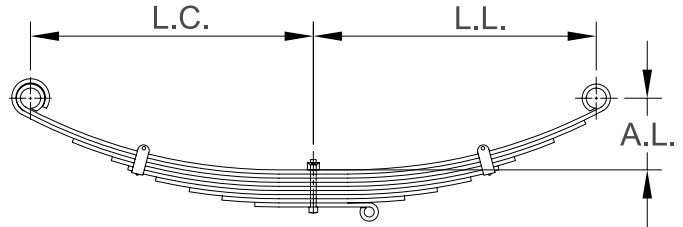

ANCHO	# HOJAS	CALIBRE	ARCO LIBRE	LONGITUD LADO CORTO	LONGITUD LADO LARGO	BUJE LADO CORTO	BUJE LADO LARGO	PUNTA LADO CORTO	PUNTA LADO LARGO
3	9 / .360	-	6 1/8	26	26	RB-124	RB-124	1	1
	1A	.360	6 1/8	26	26	RB-124	RB-124	1	1
	2A	.360	6 1/8	26	26	-	-	4	10
	3A	.360	6 1/8	21 1/2	21 1/2	-	-	10	10
	3R	.360	6 1/8	24	24	-	-	10	10
	4A	.360	6 1/8	17 5/8	17 5/8	-	-	13	13
	5A	.360	6 1/8	13 7/8	13 7/8	-	-	10	10

KA34-582A

CHRYSLER

Muelle Delantera

- Aplicación: D-600 #Original: 4729463
- Modelo: 83-85,91-92 #Rassini: 32240-B

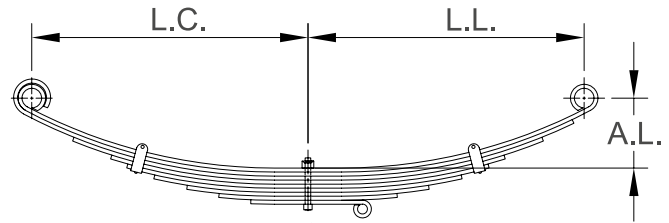

ANCHO	# HOJAS	CALIBRE	ARCO LIBRE	LONGITUD LADO CORTO	LONGITUD LADO LARGO	BUJE LADO CORTO	BUJE LADO LARGO	PUNTA LADO CORTO	PUNTA LADO LARGO
3	9 / .360	.360	5	26	26	13/8	13/4	1	1
	1A	.360	5	26	26	13/8	13/4	1	1
	2A	.360	5	26	26	-	-	4	10

KA34-227B

CHRYSLER

Muelle Delantera

- Aplicación: D-250
- Modelo: 05

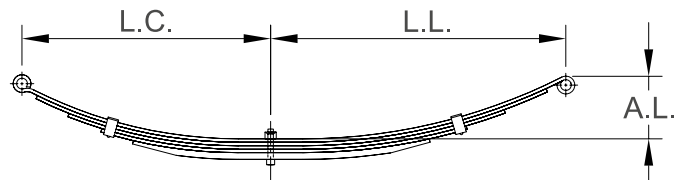

ANCHO	# HOJAS	CALIBRE	ARCO LIBRE	LONGITUD LADO CORTO	LONGITUD LADO LARGO	BUJE LADO CORTO	BUJE LADO LARGO	PUNTA LADO CORTO	PUNTA LADO LARGO
2 1/2	5 / .360	.360	8	31 1/4	30 1/2	2"	15/8	2	1
	1A	.360	8	31 1/4	30 1/2	2"	15/8	2	1
	2A	.360	8	26 1/4	26	-	-	10	10
	2R	.360	8	31 1/4	31 1/2	-	-	7A	10
	3A	.360	8	22 1/4	22	-	-	13	13

KA34-227A







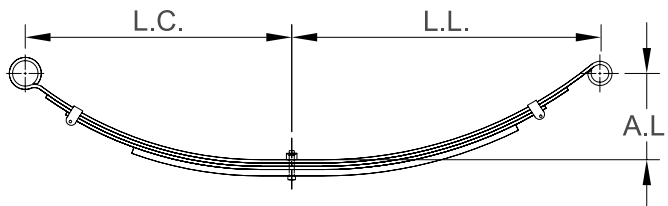

CHRYSLER

Muelle Trasera

- Aplicación: Dodge Ram 1500 Club Cab 2x4 Usa
- Modelo: 94-96

#Original: 4729935
#Rassini: 33C-500-B



ANCHO	# HOJAS	CALIBRE	ARCO LIBRE	LONGITUD LADO CORTO	LONGITUD LADO LARGO	BUJE LADO CORTO	BUJE LADO LARGO	PUNTA LADO CORTO	PUNTA LADO LARGO
2 1/2	4 / .360	.360	6 3/4	28 1/4	31 3/4	RB163	RB136	 2	3 
	1A	.360	6 3/4	28 1/4	31 3/4	RB163	RB136	 2	3 
	2A	.360	6 3/4	25 5/8	28 3/4	-	-	 10	10 
	2R	.360	6 3/4	28 1/4	30	-	-	 7A	10 

KA34-227

CHRYSLER

Muelle Trasera

- Aplicación: Ram Charger 4x4
- Modelo: 86-93
- Capacidad: 1650 lb

#Original: 4406144
#Rassini: 33C-480-A

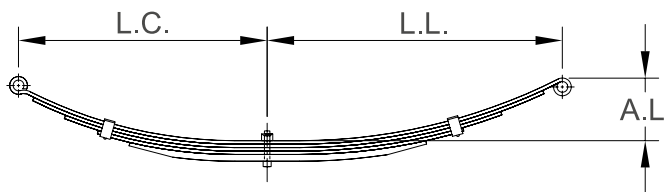

ANCHO	# HOJAS	CALIBRE	ARCO LIBRE	LONGITUD LADO CORTO	LONGITUD LADO LARGO	BUJE LADO CORTO	BUJE LADO LARGO	PUNTA LADO CORTO	PUNTA LADO LARGO
2 1/2	6 / .323	.323	5 5/8	24	28	RB81	RB81x	 2	3 
	1A	.323	5 5/8	24	28	RB81	RB81	 2	3 

KA34-045

CHRYSLER

Muelle Trasera

- Aplicación: D500-D600 C/Tirante D700 -D800
- Modelo: 69-85,91-92

#Original: 2907990
#Rassini: 33-340-B

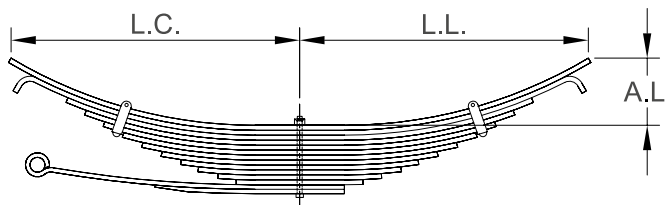

ANCHO	# HOJAS	CALIBRE	ARCO LIBRE	LONGITUD LADO CORTO	LONGITUD LADO LARGO	BUJE LADO CORTO	BUJE LADO LARGO	PUNTA LADO CORTO	PUNTA LADO LARGO
3	14 / .401	-	7 7/8	27 1/2	27 1/2	-	-	 21	21 
	1A	.401	7 7/8	27 1/2	27 1/2	-	-	 21	21 
	2A	.401	7 7/8	27 1/2	27 1/2	-	-	 18	18 

KA34-931DA

CHRYSLER

Paquete Auxiliar

- Aplicación: Dodge RAM 4000 Doble Rodada
- Modelo: 2005-2006

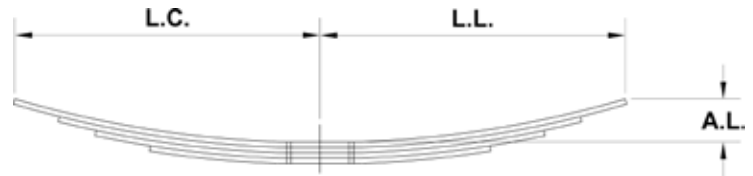

ANCHO	# HOJAS	CALIBRE	ARCO LIBRE	LONGITUD LADO CORTO	LONGITUD LADO LARGO	BUJE LADO CORTO	BUJE LADO LARGO	PUNTA LADO CORTO	PUNTA LADO LARGO
3	4 / .360	-	-	18 1/2	18 1/2	-	-	21	21
	1A	-	-	18 1/2	18 1/2	-	-	10	10
	2A	-	-	17 1/2	17 1/2	-	-	13	13
	3A	-	-	13	13	-	-	10	10
	4A	-	-	8	8	-	-	-	-

KA34-043

CHRYSLER

Muelle Trasera

- Aplicación: D-500, D-600 #Original: 2914648
- Modelo: 69-80 #Rassini: 33-340-A
- Capacidad: 9250 lb

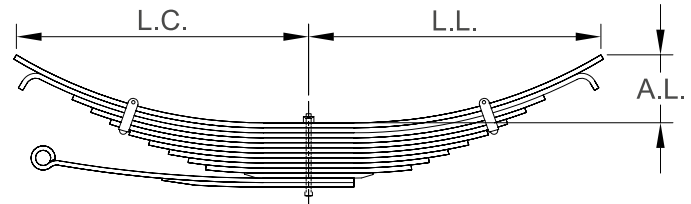

ANCHO	# HOJAS	CALIBRE	ARCO LIBRE	LONGITUD LADO CORTO	LONGITUD LADO LARGO	BUJE LADO CORTO	BUJE LADO LARGO	PUNTA LADO CORTO	PUNTA LADO LARGO
3	13 / .401.447	.401	6 5/8	29 5/8	29 5/8	-	-	21	21
	SOBRE TIRANTE	.447	2 1/2	3 1/2	25 1/2	-	-	2	21
	TIRANTE	.447	2 1/2	3 1/2	25 1/2	-	RB116	2	21

KA34-017A

CHRYSLER

Muelle Trasera

- Aplicación: Camioneta Dodge Del 24 X 24 #Original: 3492083
- Modelo: 72-73, 73-83 #Rassini: 33C-380
- Capacidad: 1650 lb

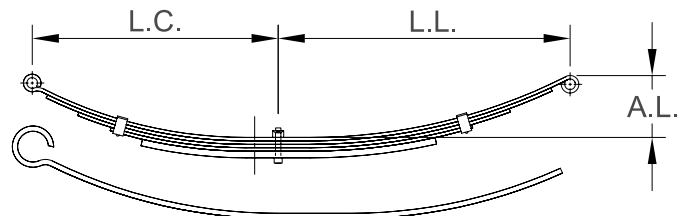

ANCHO	# HOJAS	CALIBRE	ARCO LIBRE	LONGITUD LADO CORTO	LONGITUD LADO LARGO	BUJE LADO CORTO	BUJE LADO LARGO	PUNTA LADO CORTO	PUNTA LADO LARGO
2 1/2	5 / .323	.323	5	24	28	1	1	2	3
	1A	.323	5	24	28	1	1	2	3
	2A	.323	5	22 1/2	26	-	-	10	10

KA33-340C





CHRYSLER

Muelle Trasera

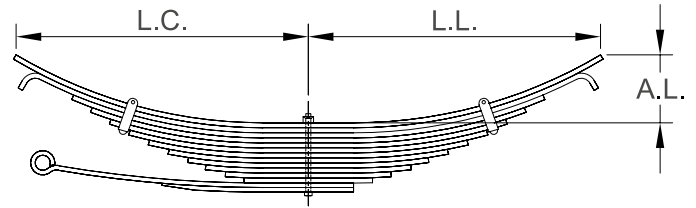
- Aplicación: D-600
- Modelo: 94

#Original: 4729764
#Rassini: 33-340-C



ANCHO	# HOJAS	CALIBRE	ARCO LIBRE	LONGITUD LADO CORTO	LONGITUD LADO LARGO	BUJE LADO CORTO	BUJE LADO LARGO	PUNTA LADO CORTO	PUNTA LADO LARGO
3	14 / .401	-	6	29 5/8	29 5/8	-	RB116	 21	21 
	1A	.401	6	29 5/8	29 5/8	-	RB116	 21	21 
	2A	.401	6	27 1/2	27 1/2	-	-	 18	18 







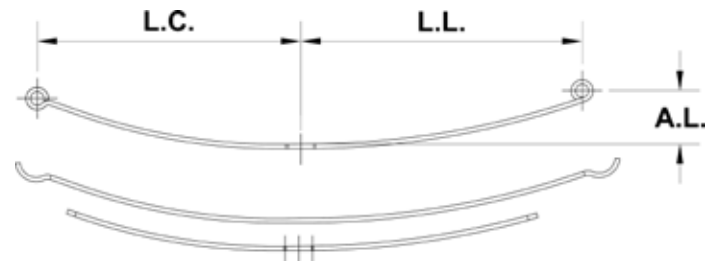

KA34-4020

CHRYSLER

Muelle

- Aplicación: RAM 4000
- Modelo: 2020



ANCHO	# HOJAS	CALIBRE	ARCO LIBRE	LONGITUD LADO CORTO	LONGITUD LADO LARGO	BUJE LADO CORTO	BUJE LADO LARGO	PUNTA LADO CORTO	PUNTA LADO LARGO
3	.5	-	6.75	28 3/8	30 3/8	2.125	1.937	 2	1 
	1A	-	6.75	28 3/8	30 3/8	-	-	 2	1 
	2A	-	6.75	26	27 1/2	-	-	 10	10 
	2R	-	6.75	38 3/8	32	-	-	 7A	10 

KA80-280-P









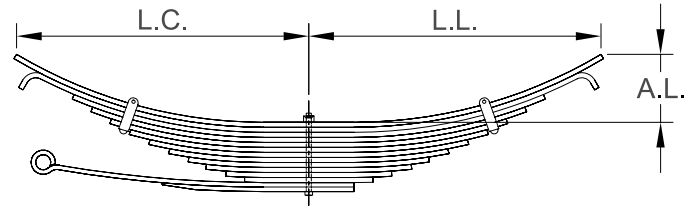

















DINA

Muelle Trasera

- Aplicación: D-500, D-533, G-533-F Con Tirante
- Modelo: 65-85

#Original: A-14532-19
#Rassini: 80-280



ANCHO	# HOJAS	CALIBRE	ARCO LIBRE	LONGITUD LADO CORTO	LONGITUD LADO LARGO	BUJE LADO CORTO	BUJE LADO LARGO	PUNTA LADO CORTO	PUNTA LADO LARGO
3	14 / .499, .447	.499	5 1/2	38	38	RNG	-	 10	10 
	SOBRE TIRANTE	.499	5 1/2	3 1/2	33	-	-	 7	21 
	SOBRE TIRANTE	.499	5 1/2	3 1/2	34 1/2	-	-	 7	21 
	1A	.499	5 1/2	38	38	RNG	-	 10	10 
	2A	.499	5 1/2	36	36	-	-	 18	18 
	3A	.499	5 1/2	28 7/8	28 7/8	-	-	 10	10 
	3R	.499	5 1/2	34	34	-	-	 10	10 
	4A	.499	5 1/2	27 1/8	27 1/8	-	-	 10	10 
	5A	.499	5 1/2	25 1/4	25 1/4	-	-	 13	13 
	6A	.447	5 1/2	23 3/8	23 3/8	-	-	 10	10 
	7A	.447	5 1/2	21 1/2	21 1/2	-	-	 10	10 
	8A	.447	5 1/2	19 1/2	19 1/2	-	-	 10	10 
	9A	.447	5 1/2	17 1/2	17 1/2	-	-	 10	10 
	10A	-	-	15	15	-	-	 13	13 
	TIRANTE	-	-	3 1/2	33	RNK	-	 2	21 









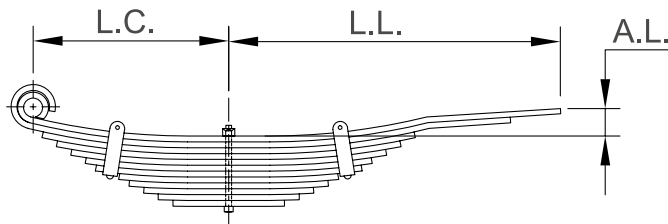



















KA71-125-P145/8

DINA

Muelle Trasera

- Aplicación: Tractocamión D761, 800, 861 #Original: BA45121
- Modelo: 67-85 #Rassini: 71125-C
- Capacidad: 17500 lb



ANCHO	# HOJAS	CALIBRE	ARCO LIBRE	LONGITUD LADO CORTO	LONGITUD LADO LARGO	BUJE LADO CORTO	BUJE LADO LARGO	PUNTA LADO CORTO	PUNTA LADO LARGO
4	14 / .625	.625	2 1/2	17 1/8	28 1/2	GAL	-	 1	21 
	3R	.625	2 1/2	17	28 1/2	-	-	 10	21 
	1A	.625	2 1/2	17	28 1/2	GAL	-	 1	21 
	2A	.625	2 1/2	17	28 1/2	-	-	 4	21 
	3A	.625	2 1/2	15 1/4	16 1/4	-	-	 10	10 
	4A	.625	2 1/2	15	14 1/2	-	-	 10	10 
	5A	.625	2 1/2	13 1/4	13 1/4	-	-	 13	13 
	6A	.625	2 1/2	11 1/4	11 1/4	-	-	 10	10 
	7A	.625	2 1/2	10 1/2	10 1/2	-	-	 10	10 
	8A	.625	2 1/2	9 1/2	9 1/2	-	-	 10	10 
	9A	.625	2 1/2	9	9	-	-	 10	10 
	10A	.625	2 1/2	8	8	-	-	 10	10 
	11A	.625	2 1/2	6 7/8	6 7/8	-	-	 10	10 
	12A	.625	2 1/2	5 3/4	5 3/4	-	-	 10	10 

KA71-125A-P

DINA

Muelle Trasera

- Aplicación: Tractocamión #Original: BA-33308
- Modelo: 76-78 #Rassini: 71-121-A
- Capacidad: 19000 lb

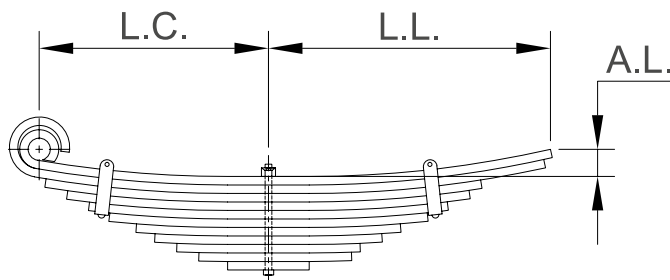

ANCHO	# HOJAS	CALIBRE	ARCO LIBRE	LONGITUD LADO CORTO	LONGITUD LADO LARGO	BUJE LADO CORTO	BUJE LADO LARGO	PUNTA LADO CORTO	PUNTA LADO LARGO
4	10 / .499	.499	2 1/2	17 3/16	20 11/16	TPK	-	 1	21 
	1A	.499	2 1/2	17 3/16	20 11/16	TPK	-	 1	21 
	2A	.499	2 1/2	17 3/16	20 11/16	-	-	 4	21 
	3R	.499	2 1/2	17 3/16	20 11/16	-	-	 10	21 

KA70-116

DINA

Muelle Delantera

- Aplicación: Tractocamión D-761
- Modelo: 67-78

#Original: 535-s2-13
#Rassini: 70-116

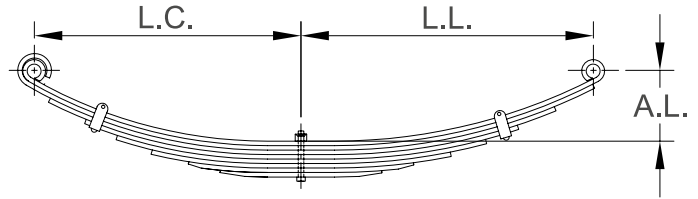

ANCHO	# HOJAS	CALIBRE	ARCO LIBRE	LONGITUD LADO CORTO	LONGITUD LADO LARGO	BUJE LADO CORTO	BUJE LADO LARGO	PUNTA LADO CORTO	PUNTA LADO LARGO
4	8 / .401.625	.401	6 1/4	25 3/16	27 5/16	TB26	TB26	 1	1 
	1A	.401	6 1/4	25 3/16	27 5/16	TB26	TB26	 1	1 
	2A	.401	6 1/4	25 3/16	27 5/16	-	-	 4	10 

KA70-113







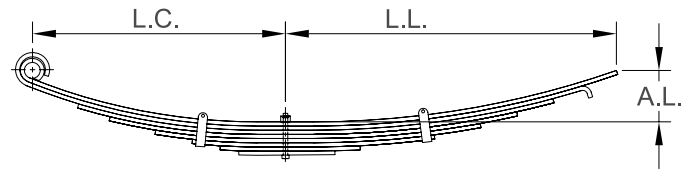

DINA

Muelle Delantera

- Aplicación: Redilas 631k 604-21
- Modelo: 66-87

#Original: A-15530-18
#Rassini: 80-260



ANCHO	# HOJAS	CALIBRE	ARCO LIBRE	LONGITUD LADO CORTO	LONGITUD LADO LARGO	BUJE LADO CORTO	BUJE LADO LARGO	PUNTA LADO CORTO	PUNTA LADO LARGO
3	10 / .447.401	.401	6	28	36	RNG	PATIN	 1	21 
	1A	.447	6	28	36	RNG	PATIN	 1	21 
	2A	.447	6	28	33	-	-	 4	18 
	3A	.447	6	25 1/2	25 1/2	-	-	 10	10 

KA55-1206-P

DINA

Muelle Delantera

- Aplicación: Dina Delantera
- Modelo: 2005
- Capacidad: 6350 lb

#Original: 3509153C92

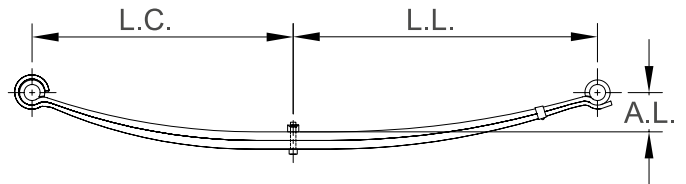

ANCHO	# HOJAS	CALIBRE	ARCO LIBRE	LONGITUD LADO CORTO	LONGITUD LADO LARGO	BUJE LADO CORTO	BUJE LADO LARGO	PUNTA LADO CORTO	PUNTA LADO LARGO
4	3 / .788	.788	3 5/8	25	29	RNK	RNK	 2	2 
	1A	.788	3 5/8	25	29	-	-	 2	2 
	2A	.788	3 5/8	25	29	-	-	 7	8 

KA55-1206A

DINA

Muelle Delantera

- Aplicación: Dina Delantera
- Modelo: 2005

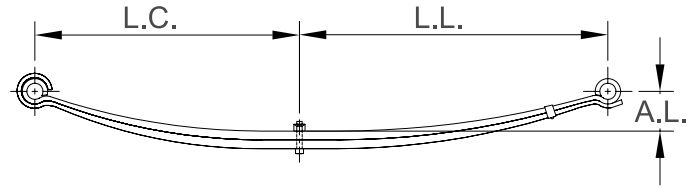

ANCHO	# HOJAS	CALIBRE	ARCO LIBRE	LONGITUD LADO CORTO	LONGITUD LADO LARGO	BUJE LADO CORTO	BUJE LADO LARGO	PUNTA LADO CORTO	PUNTA LADO LARGO
4	2 / .788	.788	3 5/8	25	29	RB253	RB253	 2	2 
	1A	.788	3 5/8	25	29	RB253	RB253	 2	2 
	2A	.788	3 5/8	25	29	-	-	 7	8 
	3A	.788	3 5/8	25	29	-	-	 8	8 

KA55-958-P3

DINA

Muelle Delantera

- Aplicación: Tracto Delantera
 - Modelo: 91-94
 - Capacidad: 4500 lb
- #Original: 573371C91

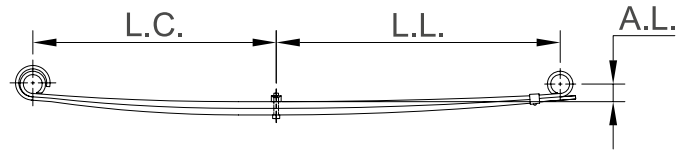

ANCHO	# HOJAS	CALIBRE	ARCO LIBRE	LONGITUD LADO CORTO	LONGITUD LADO LARGO	BUJE LADO CORTO	BUJE LADO LARGO	PUNTA LADO CORTO	PUNTA LADO LARGO
4	3 / .625	.625	6	25	29	TB26	TB26	 1	1 
	1A	.625	6	25	29	TB26	TB26	 1	1 
	2A	.625	6	25	29	-	-	 4	9 

KA55-928

DINA

Muelle Delantera

- Aplicación: S-500
 - Modelo: 90-91
 - Capacidad: 4500 lb
- #Original: 573371C91
#Rassini: 81-140-E

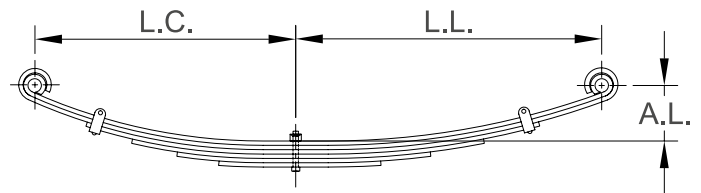

ANCHO	# HOJAS	CALIBRE	ARCO LIBRE	LONGITUD LADO CORTO	LONGITUD LADO LARGO	BUJE LADO CORTO	BUJE LADO LARGO	PUNTA LADO CORTO	PUNTA LADO LARGO
4	9 / .401	-	5 1/8	25	29	NJK	NJK	 1	1 
	1A	-	5 1/8	25	29	NJK	NJK	 1	1 
	2A	-	5 1/8	25	29	-	-	 4	10 

KA55-862

DINA

Muelle Delantera

- Aplicación: Tractocamión #Original: A-17530-18
- Modelo: 79-90 #Rassini: 70-125
- Capacidad: 8000 lb

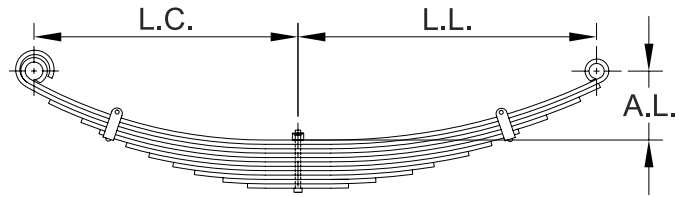

ANCHO	# HOJAS	CALIBRE	ARCO LIBRE	LONGITUD LADO CORTO	LONGITUD LADO LARGO	BUJE LADO CORTO	BUJE LADO LARGO	PUNTA LADO CORTO	PUNTA LADO LARGO
4	11 / .401	.401	6	25 1/2	28 1/2	TB26	TB26	 1	1 
	1A	.401	6	25 1/2	28 1/2	TB26	TB26	 1	1 
	2A	.401	6	25 1/2	28 1/2	-	-	 4	10 
	3A	.401	6	23 1/2	26 1/2	-	-	 10	10 
	3R	.401	6	24 3/8	27 7/8	-	-	 10	10 
	4A	.401	6	20 1/4	23 1/4	-	-	 10	10 
	5A	.401	6	18 1/2	20 1/2	-	-	 13	13 
	6A	.401	6	15 15/16	17 15/16	-	-	 10	10 
	7A	.401	6	13 3/4	15 3/4	-	-	 10	10 

KA55-564

DINA

Muelle Delantera

- Aplicación: 7 Leaf Spring #Rassini: 80-200
2,475
- Capacidad: 2475 lb

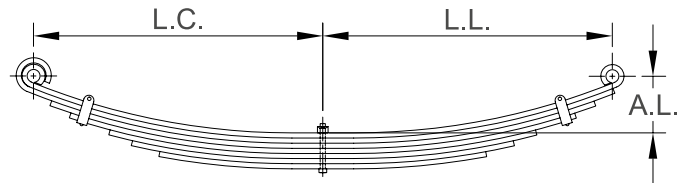









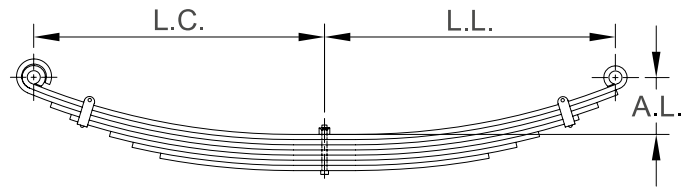





ANCHO	# HOJAS	CALIBRE	ARCO LIBRE	LONGITUD LADO CORTO	LONGITUD LADO LARGO	BUJE LADO CORTO	BUJE LADO LARGO	PUNTA LADO CORTO	PUNTA LADO LARGO
3	9 / .360	-	4	22 1/2	23	LHG	LHG	 1	1 
	1A	-	4	22 1/2	23	-	-	 1	1 
	2A	-	4	22 1/2	23	-	-	 4	10 
	3A	-	4	20 1/2	20 1/2	-	-	 13	13 
	4A	-	4	17 15/16	17 15/16	-	-	 10	10 
	5A	-	4	15 1/4	15 1/4	-	-	 10	10 
	6A	-	4	12 1/2	12 1/2	-	-	 10	10 
	7A	-	4	10 1/16	10 1/16	-	-	 13	13 
	8A	-	4	7 1/2	7 1/2	-	-	 10	10 

KA55-150
DINA
Muelle Delantera

- Aplicación: Camión Dina Delantera
- Modelo: 91-98
- Capacidad: 7000 lb

#Original: 1667493C91
#Rassini: 81-140C





ANCHO	# HOJAS	CALIBRE	ARCO LIBRE	LONGITUD LADO CORTO	LONGITUD LADO LARGO	BUJE LADO CORTO	BUJE LADO LARGO	PUNTA LADO CORTO	PUNTA LADO LARGO
4	7/.499	-	5 1/2	29	29	TB26	TB26	 1	1 
	1A	-	5 1/2	29	29	TB26	TB26	 1	1 
	2A	-	5 1/2	29	29	-	-	 4	10 
	3A	-	5 1/2	27	27	-	-	 10	10 
	3R	-	5 1/2	29	29	-	-	 10	10 
	4A	-	5 1/2	25	25	-	-	 13	13 
	5A	-	5 1/2	21	21	-	-	 10	10 
	6A	-	5 1/2	18 3/4	18 3/4	-	-	 10	10 

KA55-118
DINA
Muelle Delantera

- Aplicación: Tracto S9400 12000 Lb
- Modelo: 91-94
- Capacidad: 6000 lb

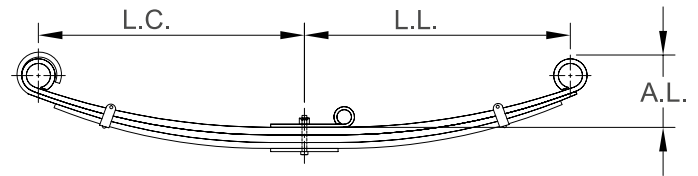
#Original: 1653685-C91
#Rassini: 81-141-E



ANCHO	# HOJAS	CALIBRE	ARCO LIBRE	LONGITUD LADO CORTO	LONGITUD LADO LARGO	BUJE LADO CORTO	BUJE LADO LARGO	PUNTA LADO CORTO	PUNTA LADO LARGO
4	3/.788	.788	4 1/2	29	29	TB26	TB26	 1	1 
	1A	.788	4 1/2	29	29	TB26	TB26	 1	1 
	2A	.788	4 1/2	29	29	-	-	 4	9 
	3A	.788	4 1/2	30	30	-	-	 9	9 

KA50-299

DINA

Muelle Trasera

- Aplicación: Tractocamión
- Modelo: 80-82
- Capacidad: 20000 lb

#Original: BA45322
#Rassini: 71-125-C

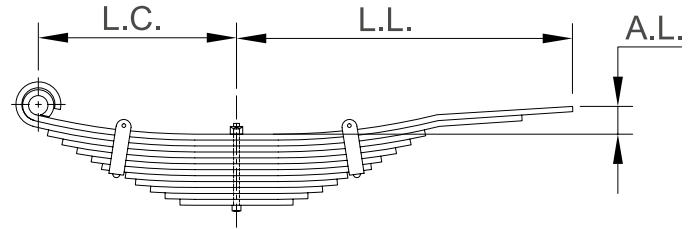

ANCHO	# HOJAS	CALIBRE	ARCO LIBRE	LONGITUD LADO CORTO	LONGITUD LADO LARGO	BUJE LADO CORTO	BUJE LADO LARGO	PUNTA LADO CORTO	PUNTA LADO LARGO
4	12 / .562, .558	.558	2 1/2	17	28 1/2	GAL	-	 1	21 
	1A	.558	2 1/2	17	28 1/2	GAL	-	 1	21 
	2A	.558	2 1/2	17	23 1/2	-	-	 4	21 
	3A	.558	2 1/2	16 1/4	15 1/4	-	-	 10	10 
	3R	.558	2 1/2	17	28 1/2	-	-	 10	21 
	4A	.558	2 1/2	15	14 1/2	-	-	 10	10 
	5A	.558	2 1/2	13 1/4	13 1/4	-	-	 13	13 

KA50-179

DINA

Muelle Trasera

- Aplicación: Tractocamión S9400-S700
- Modelo: 92

#Original: BA25694
#Rassini: 71-125C

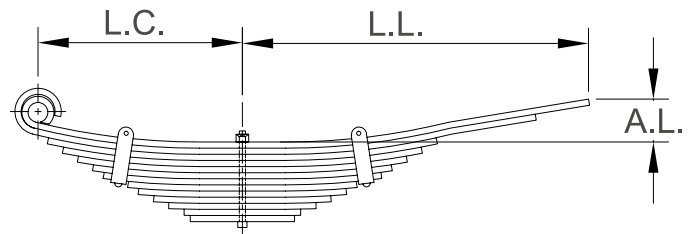

ANCHO	# HOJAS	CALIBRE	ARCO LIBRE	LONGITUD LADO CORTO	LONGITUD LADO LARGO	BUJE LADO CORTO	BUJE LADO LARGO	PUNTA LADO CORTO	PUNTA LADO LARGO
4	12 / .499	.499	2 1/8	17	28 1/2	GAL	-	 1	21 
	1A	.499	2 1/8	17	28 1/2	GAL	-	 1	21 
	2A	.499	2 1/8	17	28 1/2	-	-	 4	21 
	3A	.499	2 1/8	16 1/4	15 1/4	-	-	 10	10 
	3R	.499	2 1/8	17	28 1/2	-	-	 10	21 
	4A	.499	2 1/8	15	14 1/2	-	-	 10	10 
	5A	.499	2 1/8	13 1/4	13 1/4	-	-	 10	10 
	6A	.499	2 1/8	12 1/2	12 1/2	-	-	 10	10 
	7A	.499	2 1/8	11 3/4	11 3/4	-	-	 13	13 
	8A	.499	2 1/8	9 3/4	9 3/4	-	-	 10	10 
	9A	.499	2 1/8	9 1/8	9 1/8	-	-	 10	10 
	10A	.499	2 1/8	8	8	-	-	 10	10 
	11A	.499	2 1/8	6 7/8	6 7/8	-	-	 10	10 
	12A	.499	2 1/8	5 3/4	5 3/4	-	-	 10	10 



KA55-1219ST

DINA

Tirante Trasero

- Aplicación: Dina



ANCHO	# HOJAS	CALIBRE	ARCO LIBRE	LONGITUD LADO CORTO	LONGITUD LADO LARGO	BUJE LADO CORTO	BUJE LADO LARGO	PUNTA LADO CORTO	PUNTA LADO LARGO
3	.499	-	-	27	3 5/8	-	-	 7	21 

KA55-3012

DINA

Muelle Delantera

- Aplicación: Camión S-654
- Modelo: 2004-2012

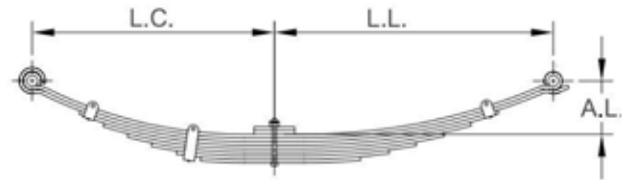

ANCHO	# HOJAS	CALIBRE	ARCO LIBRE	LONGITUD LADO CORTO	LONGITUD LADO LARGO	BUJE LADO CORTO	BUJE LADO LARGO	PUNTA LADO CORTO	PUNTA LADO LARGO
3	.499	-	3.5	30	3 5/8	RNG	RNG	 2	2 
	ESP	-	-	3 1/2	28 1/2	-	-	 21	21 
	1A	-	3.5	30	23 1/2	RNG	RNG	 2	2 
	2A	-	3.5	30	15 1/4	-	-	 7	8 
	3A	-	3.5	27 5/16	28 1/2	-	-	 21	21 
	4A	-	3.5	25 5/16	14 1/2	-	-	 21	21 
	5A	-	3.5	23 1/16	13 1/4	-	-	 21	21 

KA55-158

FAMSA

Muelle Delantera

- Aplicación: Trompo Revolvedora
- Modelo: 79-87
- Capacidad: 7200 lb

#Original:
1667499C92

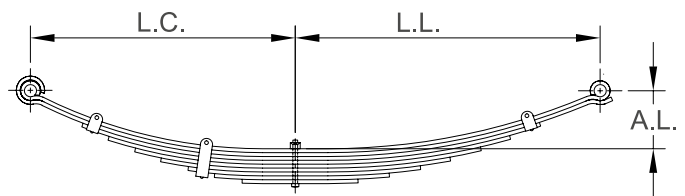

ANCHO	# HOJAS	CALIBRE	ARCO LIBRE	LONGITUD LADO CORTO	LONGITUD LADO LARGO	BUJE LADO CORTO	BUJE LADO LARGO	PUNTA LADO CORTO	PUNTA LADO LARGO
4	9 / .499	-	5 1/2	25	29	RNK	RNK	 2	2 
	1A	-	5 1/2	25	29	RNK	RNK	 2	2 
	2A	-	5 1/2	25	29	-	-	 7	8 

KA55-834

FAMSA

Muelle Delantera

- Modelo: 79-92
- Capacidad: 5400 lb

#Original: 471263-C91
#Rassini: 44-100

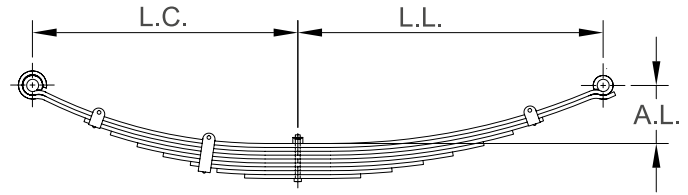

ANCHO	# HOJAS	CALIBRE	ARCO LIBRE	LONGITUD LADO CORTO	LONGITUD LADO LARGO	BUJE LADO CORTO	BUJE LADO LARGO	PUNTA LADO CORTO	PUNTA LADO LARGO
4	9 / .401	-	5 5/8	25	29	NJK	NJK	2	2
	1A	-	5 5/8	25	29	NJK	NJK	2	2
	2A	-	5 5/8	25	29	-	-	7	8
	3A	-	5 5/8	22 1/4	25 3/4	-	-	13	13
	3R	-	5 5/8	22 3/4	26 1/2	-	-	10	10
	4A	-	5 5/8	19 1/2	22 1/2	-	-	10	10
	5A	-	5 5/8	16 3/4	19 1/4	-	-	10	10
	6A	-	5 5/8	14	16	-	-	10	10
	7A	-	5 5/8	11 1/4	12 3/4	-	-	13	10
	8A	-	5 5/8	8 1/2	9 1/2	-	-	10	10
	9A	-	5 5/8	5 3/4	6 1/4	-	-	10	10
	10A	-	5 5/8	4	4	-	-	21	21

KA55-154-10H

FAMSA

Muelle Delantera

- Aplicación: Tracto Delantero
- Modelo: 87-92
- Capacidad: 6350 lb

#Original: 1661476C91
#Rassini: 44-101-A

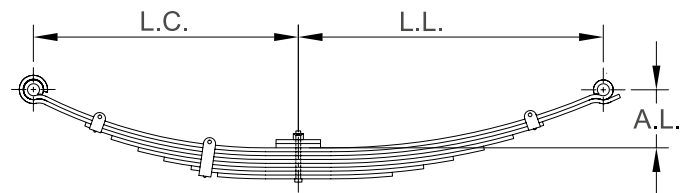

ANCHO	# HOJAS	CALIBRE	ARCO LIBRE	LONGITUD LADO CORTO	LONGITUD LADO LARGO	BUJE LADO CORTO	BUJE LADO LARGO	PUNTA LADO CORTO	PUNTA LADO LARGO
4	8 / .447	-	5 1/2	25	29	RNK	RNK	2	2
	1A	-	5 1/2	25	29	RNK	RNK	2	2
	2A	-	5 1/2	25	29	-	-	7	8
	3A	-	5 1/2	21 7/8	25 1/4	-	-	13	13
	3R	-	5 1/2	22 3/4	26 1/2	-	-	10	10
	4A	-	5 1/2	18 3/4	21 1/2	-	-	10	10
	5A	-	5 1/2	15 5/8	17 3/4	-	-	10	10
	6A	-	5 1/2	12 1/2	14	-	-	10	10
	7A	-	5 1/2	9 3/8	10 3/8	-	-	10	10

KA55-053

FAMSA

Muelle Trasera

- Aplicación: Camión S-1900 con Tirante #Original: 471292-C91 #Rassini: 45-100
- Modelo: 78-89
- Capacidad: 8820 lb

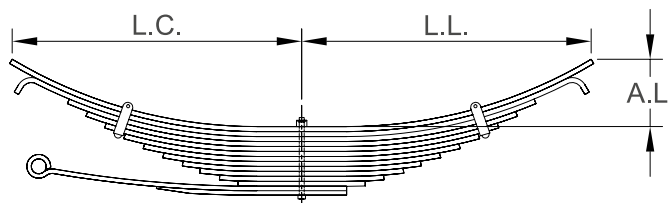

ANCHO	# HOJAS	CALIBRE	ARCO LIBRE	LONGITUD LADO CORTO	LONGITUD LADO LARGO	BUJE LADO CORTO	BUJE LADO LARGO	PUNTA LADO CORTO	PUNTA LADO LARGO
3	14 / .499, .447	.499	6 3/4	30 1/4	30 1/4	-	RNG	21	21
	SOBRE TIRANTE	.499	6 3/4	26 1/2	3 3/4	-	-	7	21
	1A	.499	6 3/4	30 1/4	30 1/4	-	-	21	21
	2A	.499	6 3/4	27	27	-	-	11	11
	3A	.499	6 3/4	24	24	-	-	10	10
	3R	.499	6 3/4	26	26	-	-	10	10
	4A	.499	6 3/4	21 1/4	21 1/4	-	-	10	10
	4R	.499	6 3/4	23	23	-	-	10	10
	5A	.499	6 3/4	18 1/2	18 1/2	-	-	13	13
	6A	.499	6 3/4	15 5/8	15 5/8	-	-	10	10
	7A	.447	6 3/4	12 7/8	12 7/8	-	-	10	10
	8A	.447	6 3/4	10 5/8	10 5/8	-	-	10	10
	9A	.447	6 3/4	8 1/2	8 1/2	-	-	10	10
	13A	.447	6 3/4	26 1/2	3 3/4	RNG	-	2	21

KA44-120

FAMSA

Muelle Delantera

- Aplicación: Thorton S1900 #Original: 572363-C91 #Rassini: 44-120
- Modelo: 79-87
- Capacidad: 5400 lb

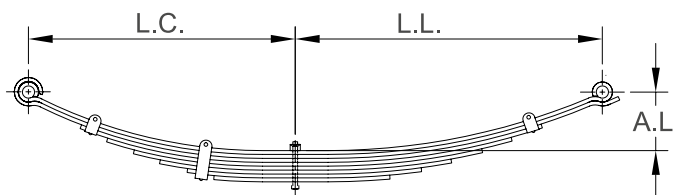

ANCHO	# HOJAS	CALIBRE	ARCO LIBRE	LONGITUD LADO CORTO	LONGITUD LADO LARGO	BUJE LADO CORTO	BUJE LADO LARGO	PUNTA LADO CORTO	PUNTA LADO LARGO
4	8 / .401	.401	5 1/2	25	29	NJK	NJK	2	2
	1A	.401	5 1/2	25	29	NJK	NJK	2	2
	2A	.401	5 1/2	25	29	-	-	7	8
	3A	.401	5 1/2	20	23	-	-	13	13
	4A	.401	5 1/2	15 1/2	18	-	-	10	10

KA43-1679

FORD

Muelle Trasera

- Aplicación: Ford Lobo Pickup #Original: 4L34-5560-RD
- Modelo: 2005 #Rassini: 13C-370-A

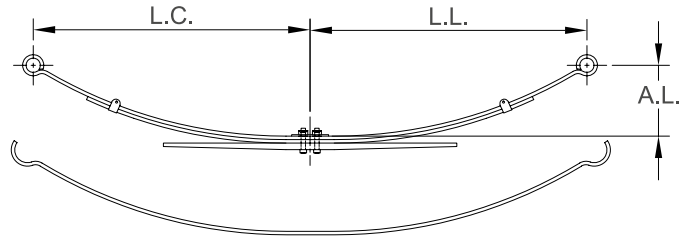

ANCHO	# HOJAS	CALIBRE	ARCO LIBRE	LONGITUD LADO CORTO	LONGITUD LADO LARGO	BUJE LADO CORTO	BUJE LADO LARGO	PUNTA LADO CORTO	PUNTA LADO LARGO
3	3 / .401,.625	.401	7	25 5/8	31 5/16	1 5/8	1 1/4	2	2
	1A	.401	-	25 5/8	31 5/16	RB275	RB133	2	2
	2A	.401	-	20 1/2	25	-	-	16	16
	2R	.401	-	25 5/8	31 5/16	-	-	7A	7A
	3A	.625	-	12 7/8	15 5/8	-	-	15	15

KA43-1291

FORD

Muelle Trasera

- Aplicación: F450-F550 Helper 7/16 #Original: F81Z-5560BB
- Modelo: 99-06
- Capacidad: 1050 lb

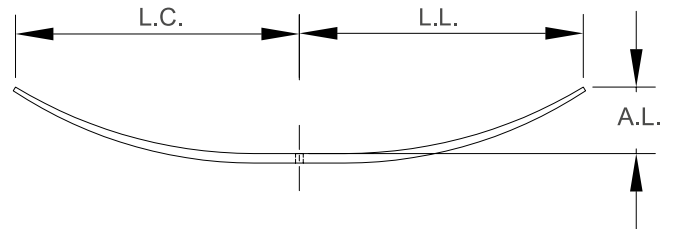

ANCHO	# HOJAS	CALIBRE	ARCO LIBRE	LONGITUD LADO CORTO	LONGITUD LADO LARGO	BUJE LADO CORTO	BUJE LADO LARGO	PUNTA LADO CORTO	PUNTA LADO LARGO
3	1 / .625	-	5 1/4	21	22 1/4	-	-	16	16

KA43-1289

FORD

Muelle Trasera

- Aplicación: F450-F550 Spring 7/16 #Original: F81Z5560BB
- Modelo: 99-06 #Rassini: 43-1289

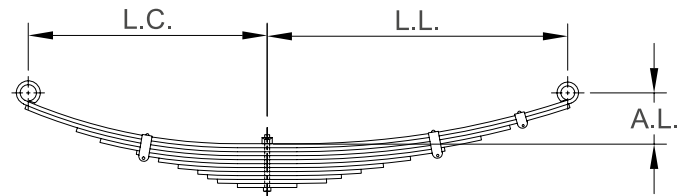

ANCHO	# HOJAS	CALIBRE	ARCO LIBRE	LONGITUD LADO CORTO	LONGITUD LADO LARGO	BUJE LADO CORTO	BUJE LADO LARGO	PUNTA LADO CORTO	PUNTA LADO LARGO
3	10 / .473,.423,.401	-	5 1/8	25	30 3/4	RB177	RB158	1	1
	1A	-	5 1/8	25	30 3/4	RB243	RB244	1	1

KA43-1279
FORD
Muelle Trasera

- Aplicación: F250-F350 #Original: F81Z5588CA
Single Leaf Helper
- Modelo: 99-01
- Capacidad: 400 lb

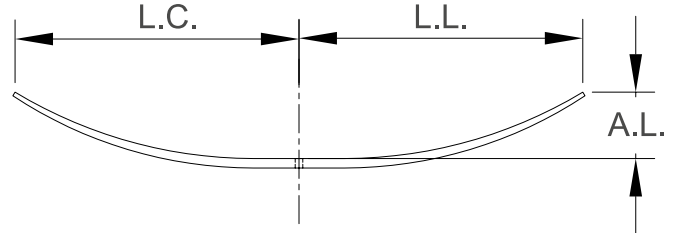



ANCHO	# HOJAS	CALIBRE	ARCO LIBRE	LONGITUD LADO CORTO	LONGITUD LADO LARGO	BUJE LADO CORTO	BUJE LADO LARGO	PUNTA LADO CORTO	PUNTA LADO LARGO
3	1 / .447	.447	4	20 3/4	21 1/4	-	-	 16	16 

KA43-1263
FORD
Muelle Trasera

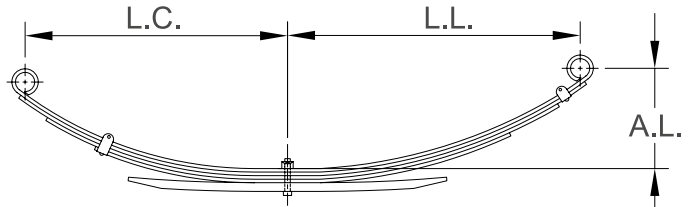
- Aplicación: F250-F350 #Original: F81Z5560CD
Super Duty Spring
- Modelo: 99-07
- Capacidad: 3000 lb





ANCHO	# HOJAS	CALIBRE	ARCO LIBRE	LONGITUD LADO CORTO	LONGITUD LADO LARGO	BUJE LADO CORTO	BUJE LADO LARGO	PUNTA LADO CORTO	PUNTA LADO LARGO
3	5 / .360,.788	-	8 3/16	25	33 1/8	RB245	RB244	 1	1 

KA43-1261
FORD
Muelle Trasera

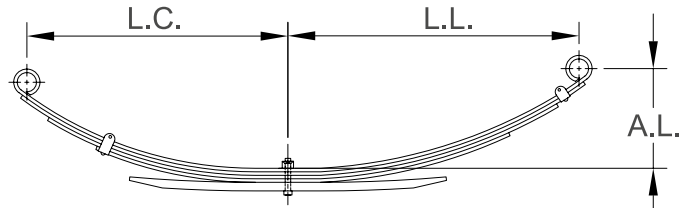
- Aplicación: F250-F350 5 #Original: F81Z5560BA
Leaf Spring
- Modelo: 99-07
- Capacidad: 2700 lb





ANCHO	# HOJAS	CALIBRE	ARCO LIBRE	LONGITUD LADO CORTO	LONGITUD LADO LARGO	BUJE LADO CORTO	BUJE LADO LARGO	PUNTA LADO CORTO	PUNTA LADO LARGO
3	5 / .360,.788	-	7 7/8	25	33 1/8	RB245	RB244	 1	1 

KA43-1199
FORD
Muelle Trasera

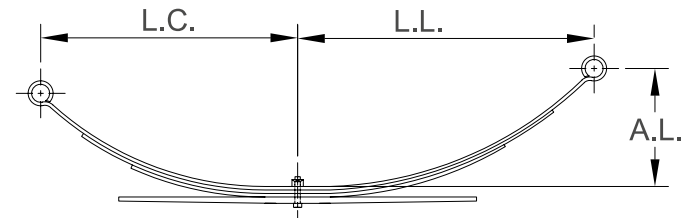
- Aplicación: F150 4 Leaf Spring #Original: F65Z-5560NA
- Modelo: 97-98
- Capacidad: 1415 lb



ANCHO	# HOJAS	CALIBRE	ARCO LIBRE	LONGITUD LADO CORTO	LONGITUD LADO LARGO	BUJE LADO CORTO	BUJE LADO LARGO	PUNTA LADO CORTO	PUNTA LADO LARGO
2 1/2	4 / .323,.625	-	8 9/16	26 3/8	32 1/8	RB235-B	RB236-B	 2	2 

KA43-1117

FORD

Muelle Trasera

- Aplicación: F-350
- Modelo: 91-94
- Capacidad: 3225 lb

#Original: E7TA-5560-V
#Rassini: 13C-300C

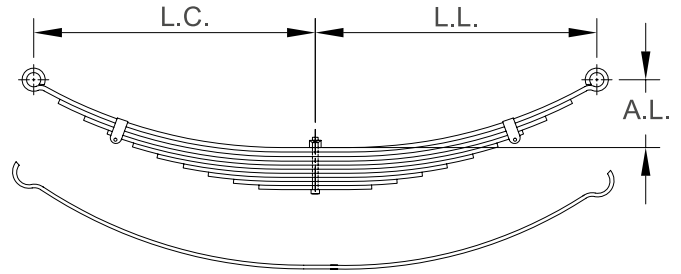

ANCHO	# HOJAS	CALIBRE	ARCO LIBRE	LONGITUD LADO CORTO	LONGITUD LADO LARGO	BUJE LADO CORTO	BUJE LADO LARGO	PUNTA LADO CORTO	PUNTA LADO LARGO
2 1/4	10 / .401, .360	.401	8 7/8	26	26	RB101	RB101	2	2
	1A	.401	8 7/8	26	26	RB101	RB101	2	2
	2A	.401	8 7/8	23 1/2	23 1/2	-	-	10	10
	2R	.401	8 7/8	26	26	-	-	7A	7A
	3A	.360	8 7/8	21	21	-	-	10	10
	4A	.360	8 7/8	18 3/4	18 3/4	-	-	13	13

KA43-1085

FORD

Muelle Trasera

- Aplicación: E350 Chassis Cab Spring
- Capacidad: 3460 lb

#Original: F3UZ5560A

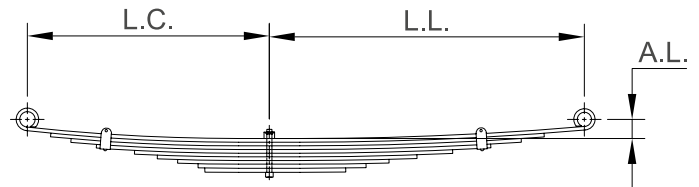

ANCHO	# HOJAS	CALIBRE	ARCO LIBRE	LONGITUD LADO CORTO	LONGITUD LADO LARGO	BUJE LADO CORTO	BUJE LADO LARGO	PUNTA LADO CORTO	PUNTA LADO LARGO
3	9 / .401, .323	-	1 7/8	23 13/16	31	RB198	RB157	1	1

KA43-1071

FORD

Muelle Trasera

- Aplicación: Ford Ranger 3 Leaf Rear Spring
- Modelo: 98-99

#Original: F3TZ5560B
#Rassini: 13C-340

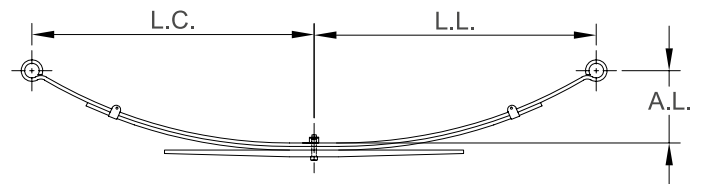

ANCHO	# HOJAS	CALIBRE	ARCO LIBRE	LONGITUD LADO CORTO	LONGITUD LADO LARGO	BUJE LADO CORTO	BUJE LADO LARGO	PUNTA LADO CORTO	PUNTA LADO LARGO
2 1/2	3 / .323, .590	-	6 15/16	25 11/16	30 15/16	1 5/8	1 3/8	2	2

KA43-1041

FORD

Muelle Trasera

- Aplicación: E250/E350 5 Leaf Spring
- Capacidad: 3000 lb

#Original: F2UZ5560E
#Rassini: 43-1153

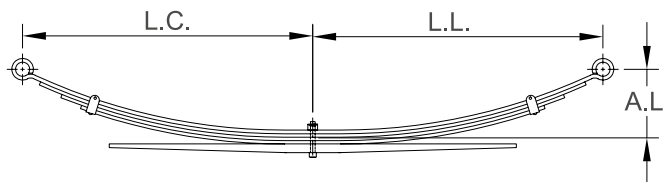

ANCHO	# HOJAS	CALIBRE	ARCO LIBRE	LONGITUD LADO CORTO	LONGITUD LADO LARGO	BUJE LADO CORTO	BUJE LADO LARGO	PUNTA LADO CORTO	PUNTA LADO LARGO
3	5 / .360,.625	-	4	23 7/8	31	RB198	RB152	2	2

KA43-1003

FORD

Muelle Trasera

- Aplicación: Single Axle Spring-13 Leaves
- Modelo: 80-83
- Capacidad: 10400 lb

#Original: F2HZ5560D

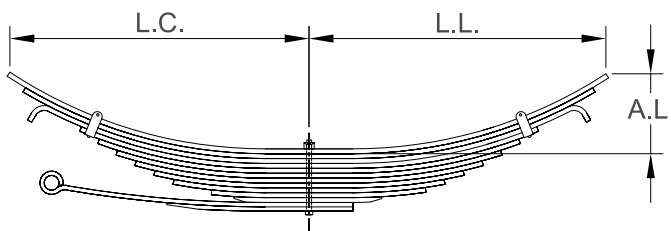

ANCHO	# HOJAS	CALIBRE	ARCO LIBRE	LONGITUD LADO CORTO	LONGITUD LADO LARGO	BUJE LADO CORTO	BUJE LADO LARGO	PUNTA LADO CORTO	PUNTA LADO LARGO
3	13 / .499,.447,.401	-	5 1/2	29 5/8	29 5/8	-	-	21	21

KA43-967

FORD

Muelle Trasera

- Aplicación: Explorer, Ranger
- Modelo: 1997
- Capacidad: 1240 lb

#Original: EW7-368

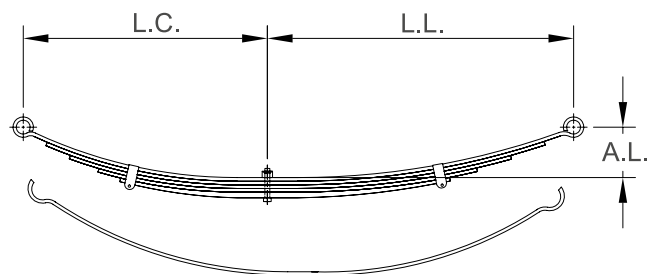

ANCHO	# HOJAS	CALIBRE	ARCO LIBRE	LONGITUD LADO CORTO	LONGITUD LADO LARGO	BUJE LADO CORTO	BUJE LADO LARGO	PUNTA LADO CORTO	PUNTA LADO LARGO
2 1/2	5 / .360	.360	4 3/4	25 11/16	30 15/16	RB-150	HULE 1 1/8	2	2
	1A	.360	4 3/4	25 11/16	30 15/16	RB-150	HULE 1 1/8	2	2
	2R	.360	4 3/4	28	33 1/8	-	-	7A	7A

KA43-899-P

FORD

Muelle Trasera

- Aplicación: Camioneta Super Duty 5 t
- Modelo: 1997
- Capacidad: 4500 lb

#Original: E8TZ5560A
#Rassini: 43-1289

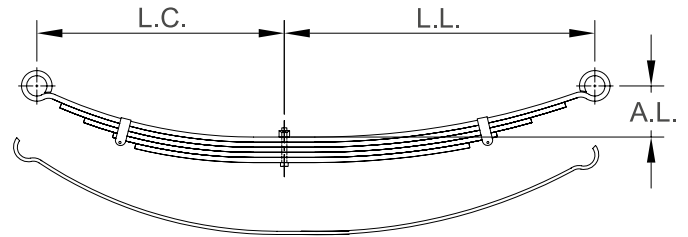

ANCHO	# HOJAS	CALIBRE	ARCO LIBRE	LONGITUD LADO CORTO	LONGITUD LADO LARGO	BUJE LADO CORTO	BUJE LADO LARGO	PUNTA LADO CORTO	PUNTA LADO LARGO
3	6 / .499	.499	5 1/2	25 1/8	30 5/8	RB177	RB178	1	1
	1A	.499	5 1/2	25 1/8	30 5/8	RB177	RB178	1	1
	2A	.499	5 1/2	22 1/8	27 5/8	-	-	10	10
	2R	.499	5 1/2	25 1/8	30 5/8	-	-	7A	7A
	3A	.499	5 1/2	20	25	-	-	10	10
	4A	.499	5 1/2	18	23	-	-	13	13

KA43-899A

FORD

Muelle Trasera

- Aplicación: Camioneta Super Duty 5 T
- Modelo: 1997

#Original: E8TZ5560A
#Rassini: 13C-400

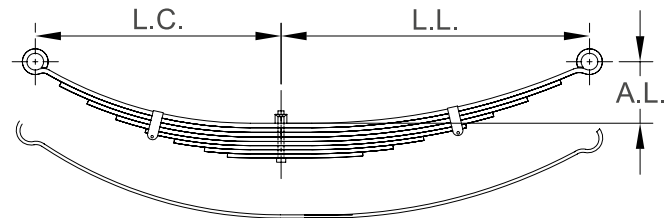

ANCHO	# HOJAS	CALIBRE	ARCO LIBRE	LONGITUD LADO CORTO	LONGITUD LADO LARGO	BUJE LADO CORTO	BUJE LADO LARGO	PUNTA LADO CORTO	PUNTA LADO LARGO
3	6 / .401	.401	4 1/4	25 1/2	30	RB177	RB178	1	1
	1A	.401	4 1/4	25 1/2	30	RB177	RB178	1	1
	2R	.401	4 1/4	25 1/2	30	-	-	5	5

KA43-863

FORD

Muelle Trasera

- Aplicación: Ranger 4 Leaf Spring 1350
- Modelo: 83-03
- Capacidad: 1350 lb

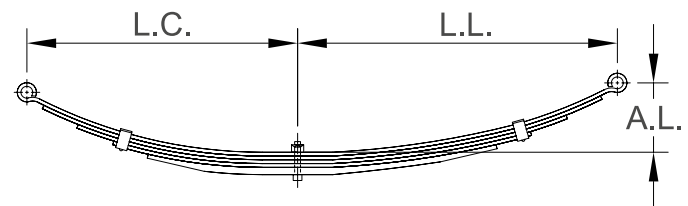

ANCHO	# HOJAS	CALIBRE	ARCO LIBRE	LONGITUD LADO CORTO	LONGITUD LADO LARGO	BUJE LADO CORTO	BUJE LADO LARGO	PUNTA LADO CORTO	PUNTA LADO LARGO
2 1/2	4 / .323,625	-	5	25 5/8	31	RB159-B	RB160-B	2	2

KA43-883-P



FORD

Muelle Trasera

- Aplicación: F-200
- Modelo: 88-89
- Capacidad: 1660 lb

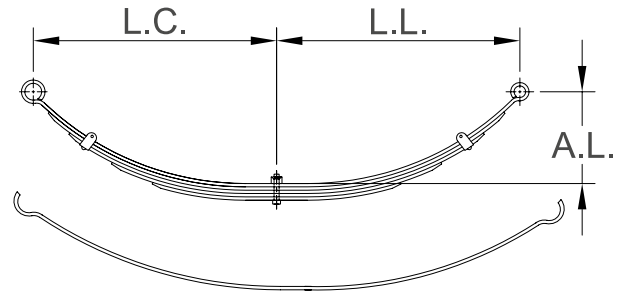
#Original: 89TY-5560-A
#Rassini: 13C-360-A



ANCHO	# HOJAS	CALIBRE	ARCO LIBRE	LONGITUD LADO CORTO	LONGITUD LADO LARGO	BUJE LADO CORTO	BUJE LADO LARGO	PUNTA LADO CORTO	PUNTA LADO LARGO
2 1/2	5 / .323	.323	8 7/8	25	32	RB 101	RB 101	 2	2 
	1A	.323	8 7/8	25	32	RB 101	RB 101	 2	2 
	2A	.323	8 7/8	23	29 1/2	-	-	 10	10 
	2R	.323	8 7/8	25	32	-	-	 7A	7A 
	3A	.323	8 7/8	20	25 1/2	-	-	 10	10 
	4A	.323	8 7/8	17	21 1/2	-	-	 13	10 

KA43-818A-P

FORD

Muelle Delantera

- Aplicación: Camioneta 5 Tns. Super Duty
- Modelo: 86-89, 1997
- Capacidad: 2160 lb

#Rassini: 43-774

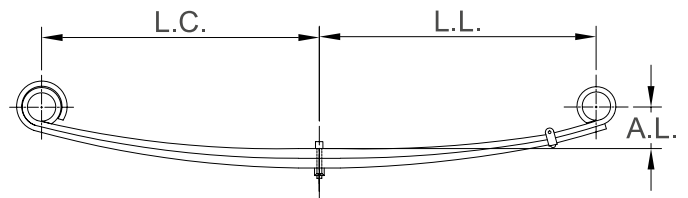

ANCHO	# HOJAS	CALIBRE	ARCO LIBRE	LONGITUD LADO CORTO	LONGITUD LADO LARGO	BUJE LADO CORTO	BUJE LADO LARGO	PUNTA LADO CORTO	PUNTA LADO LARGO
3	2 / .625	.625	4	27 1/2	28 1/8	RB-247	RB-248	 1	1 
	1A	.625	4	27 1/2	28 1/8	RB-248	RB-248	 1	1 

KA43-818

FORD

Muelle Delantera

- Aplicación: Ford Delantera
- Modelo: 2005
- Capacidad: 2620 lb

#Original: YC3Z5310AN
#Rassini: 43-778

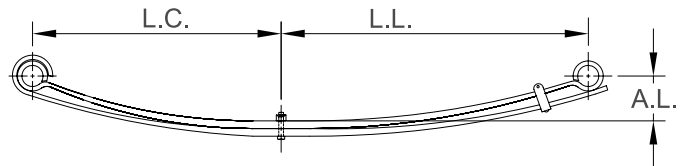

ANCHO	# HOJAS	CALIBRE	ARCO LIBRE	LONGITUD LADO CORTO	LONGITUD LADO LARGO	BUJE LADO CORTO	BUJE LADO LARGO	PUNTA LADO CORTO	PUNTA LADO LARGO
3	2 / .625	.625	4	27 1/2	28 1/8	RB-247	RB-248	 2	2 
	1A	.625	4	27 1/2	28 1/8	RB-247	RB-248	 2	2 
	2A	.625	4	27 1/2	28 1/8	-	-	 4	9 

KA43-816

FORD

Muelle Delantera

- Aplicación: 2 Leaf Super Duty Taper #Original: YC3Z5310AM #Rassini: 43-778R
- Modelo: 99-04

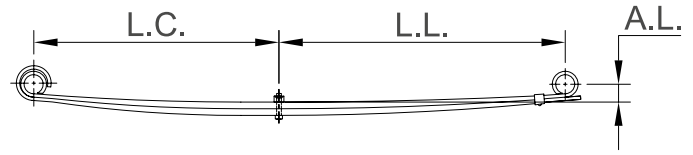

ANCHO	# HOJAS	CALIBRE	ARCO LIBRE	LONGITUD LADO CORTO	LONGITUD LADO LARGO	BUJE LADO CORTO	BUJE LADO LARGO	PUNTA LADO CORTO	PUNTA LADO LARGO
3	2 / .625	-	4 7/8	27 1/2	28 1/8	RB247	RB248	1	1

KA43-812

FORD

Muelle Delantera

- Aplicación: 2 Leaf Super Duty Taper #Original: YC3Z5310AK
- Modelo: 99-04

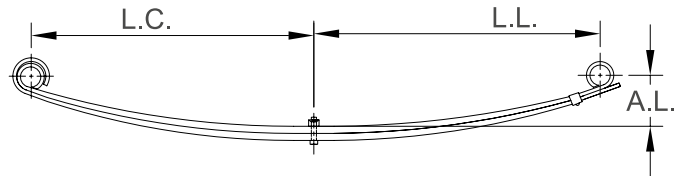

ANCHO	# HOJAS	CALIBRE	ARCO LIBRE	LONGITUD LADO CORTO	LONGITUD LADO LARGO	BUJE LADO CORTO	BUJE LADO LARGO	PUNTA LADO CORTO	PUNTA LADO LARGO
3	2 / .590	-	4 3/4	27 1/2	28 1/8	RB227	RB158	1	1

KA43-803

FORD

Muelle Trasera

- Aplicación: F250-F350 Spring 3" Wide #Original: E3TZ5560M
- Modelo: 80-98
- Capacidad: 2810 lb

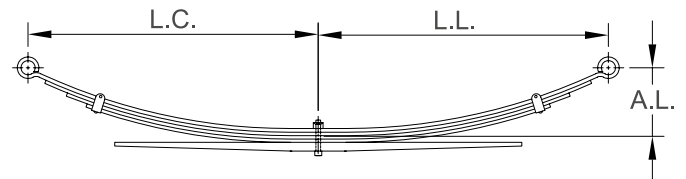

ANCHO	# HOJAS	CALIBRE	ARCO LIBRE	LONGITUD LADO CORTO	LONGITUD LADO LARGO	BUJE LADO CORTO	BUJE LADO LARGO	PUNTA LADO CORTO	PUNTA LADO LARGO
3	5 / .360,.702	-	7	25	31	RB158	RB152	2	2
	1A	-	7	25	31	RB158	RB152	2	2
	2A	-	7	22 3/4	26	-	-	10	10
	2R	-	7	25	31	-	-	7A	7A
	3A	-	7	20 1/2	24 1/2	-	-	10	10
	4A	-	7	17 1/4	20 3/4	-	-	13	13
	5A	-	7	14 1/2	17 1/2	-	-	15	15









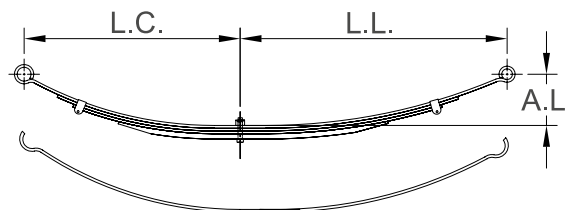

KA43-781A-P

FORD

Muelle Trasera

- Aplicación: Ford Lobo #Original: F65A-ADEW7
- Modelo: 91-94 #Rassini: 13C-370



ANCHO	# HOJAS	CALIBRE	ARCO LIBRE	LONGITUD LADO CORTO	LONGITUD LADO LARGO	BUJE LADO CORTO	BUJE LADO LARGO	PUNTA LADO CORTO	PUNTA LADO LARGO
2 1/2	4 / .323	.323	6	26 3/8	32 1/8	RB104	RB101	 2	2 
	1A	.323	6	26 3/8	32 1/8	RB104	RB101	 2	2 
	2A	.323	6	22	26	-	-	 10	10 
	2R	.323	6	26 3/8	32 1/8	-	-	 7A	7A 
	3A	.323	6	20	24	-	-	 13	13 





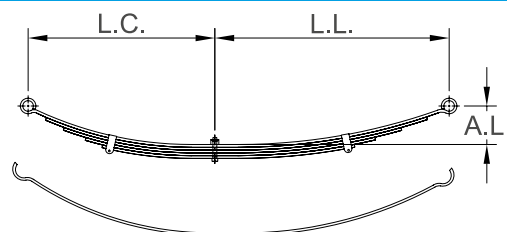

KA43-781

FORD

Muelle Trasera

- Aplicación: Camioneta Pickup Ranger #Original: EW7-368
- Modelo: 1997 #Rassini: 13C-421
- Capacidad: 1250 lb



ANCHO	# HOJAS	CALIBRE	ARCO LIBRE	LONGITUD LADO CORTO	LONGITUD LADO LARGO	BUJE LADO CORTO	BUJE LADO LARGO	PUNTA LADO CORTO	PUNTA LADO LARGO
2 1/2	5 / .360	.360	6	25 5/8	31	RB104	RB112	 2	2 
	1A	.360	6	25 5/8	31	RB104	RB112	 2	2 
	2R	-	6	25 5/8	31	-	-	 7A	7A 

KA43-723

FORD

Muelle Trasera

- Aplicación: F150 4 Leaf Spring #Original: EOTZ5560Y
- Modelo: 81-97 #Rassini: 13C-370-A
- Capacidad: 1750 lb

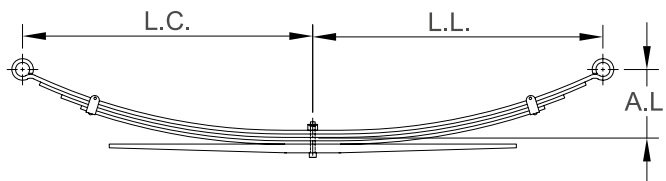

ANCHO	# HOJAS	CALIBRE	ARCO LIBRE	LONGITUD LADO CORTO	LONGITUD LADO LARGO	BUJE LADO CORTO	BUJE LADO LARGO	PUNTA LADO CORTO	PUNTA LADO LARGO
3	4 / .323,291,625	-	8 1/4	25	31	RB158	RB152	 2	2 

KA43-711

FORD

Muelle Trasera

- Aplicación: F150 Spring 1,850
- Modelo: 80-96
- Capacidad: 1850 lb

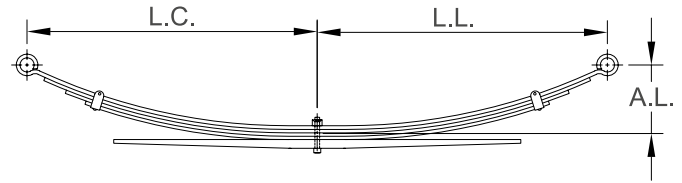

ANCHO	# HOJAS	CALIBRE	ARCO LIBRE	LONGITUD LADO CORTO	LONGITUD LADO LARGO	BUJE LADO CORTO	BUJE LADO LARGO	PUNTA LADO CORTO	PUNTA LADO LARGO
2 1/2	5 / .323,.291,.625	-	7 3/4	25	31	RB159-B	RB131	2	2

KA43-701-P

FORD

Muelle Trasera

- Aplicación: Camioneta Pickup
 - Modelo: 1997
 - Capacidad: 2977 lb
- #Original: EW7-368
#Rassini: 13C-400

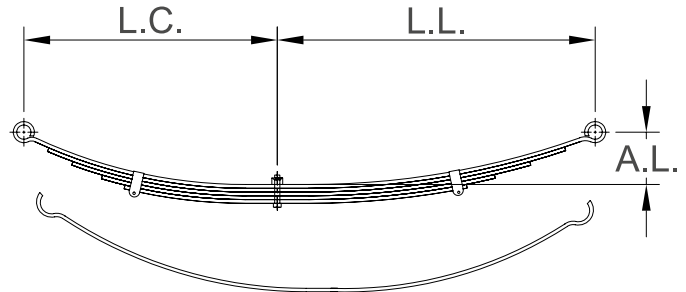

ANCHO	# HOJAS	CALIBRE	ARCO LIBRE	LONGITUD LADO CORTO	LONGITUD LADO LARGO	BUJE LADO CORTO	BUJE LADO LARGO	PUNTA LADO CORTO	PUNTA LADO LARGO
3	5 / .360	.447	4 1/2	25	31	RB158	RB157	2	2
	1A	.360	4 1/2	25	31	RB158	RB157	2	2
	2A	.360	4 1/2	22 1/2	28	-	-	10	10
	2R	.360	4 1/2	25	31	-	-	7A	7A
	3A	.360	4 1/2	20	24 1/2	-	-	13	13

KA43-698

FORD

Muelle Delantera

- Aplicación: 9 Leaf Spring 9,200
 - Capacidad: 9200 lb
- #Original: F6HZ5310ACA

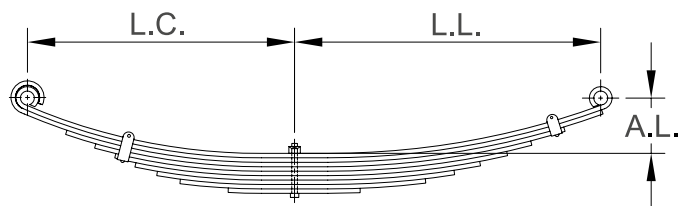

ANCHO	# HOJAS	CALIBRE	ARCO LIBRE	LONGITUD LADO CORTO	LONGITUD LADO LARGO	BUJE LADO CORTO	BUJE LADO LARGO	PUNTA LADO CORTO	PUNTA LADO LARGO
4	9 / .558,.499,.423,WDC	-	4 5/8	25	29	RNK	RNK	1	1

KA43-695

FORD

Muelle Trasera

- Modelo: 80-98
- Capacidad: 2450 lb

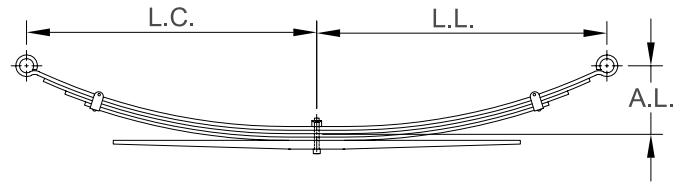

ANCHO	# HOJAS	CALIBRE	ARCO LIBRE	LONGITUD LADO CORTO	LONGITUD LADO LARGO	BUJE LADO CORTO	BUJE LADO LARGO	PUNTA LADO CORTO	PUNTA LADO LARGO
3	5 / .323,.625	-	8 3/8	25	31 3/8	RB158	RB152	 2	2 

KA43-694





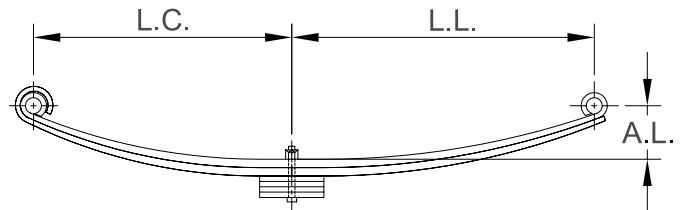

FORD

Muelle Delantera

- Aplicación: Ford Sterlin
- Modelo: 98
- Capacidad: 5400 lb

#Original:
F6HT5310KA



ANCHO	# HOJAS	CALIBRE	ARCO LIBRE	LONGITUD LADO CORTO	LONGITUD LADO LARGO	BUJE LADO CORTO	BUJE LADO LARGO	PUNTA LADO CORTO	PUNTA LADO LARGO
2	2 / .788	-	5	25	29	RNK	RNK	 1	1 
	1A	-	5	25	29	RNK	RNK	 1	1 
	2A	-	5	25	29	-	-	 4	9 

KA43-689

FORD

Muelle Trasera

- Aplicación: F250 Spring 25x32" 3"W
- Modelo: 81-97
- Capacidad: 1700 lb

#Original:
EOTZ5560B
#Rassini: 13C-370-A

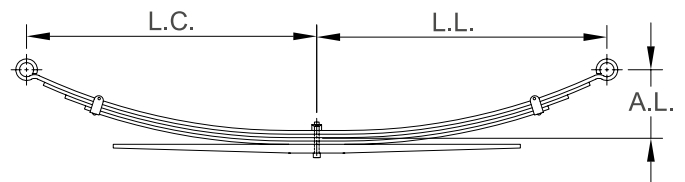

ANCHO	# HOJAS	CALIBRE	ARCO LIBRE	LONGITUD LADO CORTO	LONGITUD LADO LARGO	BUJE LADO CORTO	BUJE LADO LARGO	PUNTA LADO CORTO	PUNTA LADO LARGO
3	4 / .323,.291,.625	-	9 1/4	25	32	RB158	RB152	 2	2 

KA43-682

FORD

Muelle Delantera

- Aplicación: Ford Front Spring 8,200
- Capacidad: 8200 lb

#Original:
F6HZ5310ABA

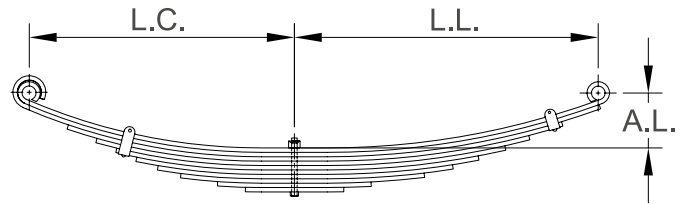

ANCHO	# HOJAS	CALIBRE	ARCO LIBRE	LONGITUD LADO CORTO	LONGITUD LADO LARGO	BUJE LADO CORTO	BUJE LADO LARGO	PUNTA LADO CORTO	PUNTA LADO LARGO
4	9 / .527,.499,.423	-	5	25	29	RNK	RNK	1	1

KA43-623

FORD

Muelle Trasera

- Aplicación: E350 Van Spring 10-Lvs
- Modelo: 75-91
- Capacidad: 3300 lb

#Original:
D5UZ5560F

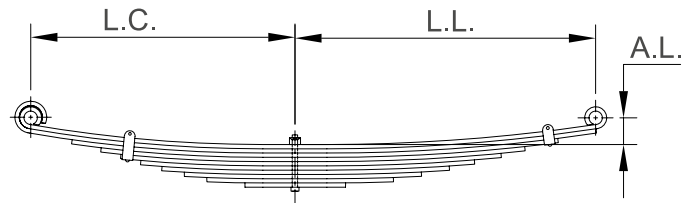

ANCHO	# HOJAS	CALIBRE	ARCO LIBRE	LONGITUD LADO CORTO	LONGITUD LADO LARGO	BUJE LADO CORTO	BUJE LADO LARGO	PUNTA LADO CORTO	PUNTA LADO LARGO
3	10 / .360	.360	2 1/2	23 13/16	31	RB132	RB133	1	1

KA43-611

FORD

Muelle Trasera

- Aplicación: F-350
- Modelo: 91-94
- Capacidad: 1825 lb

#Original:
E7TA-5560-V
#Rassini: 13C360C

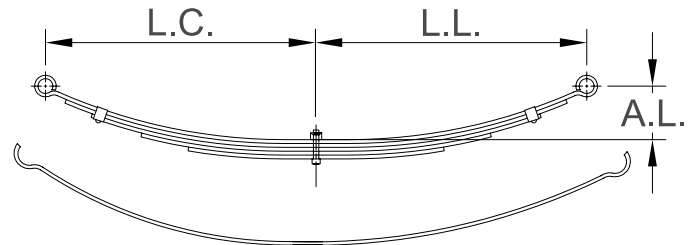

ANCHO	# HOJAS	CALIBRE	ARCO LIBRE	LONGITUD LADO CORTO	LONGITUD LADO LARGO	BUJE LADO CORTO	BUJE LADO LARGO	PUNTA LADO CORTO	PUNTA LADO LARGO
3	5 / .360 .323 .291	.360	5	23 13/16	31	RB-132	RB-133	1	1
	1A	-	5	23 13/16	31	RB-132	RB-133	1	1
	2R	-	5	23 13/16	31	-	-	7A	7A

KA43-571
FORD
Muelle Trasera

- Aplicación: F250 Spring 3"W. 1973-79
- Modelo: 73-79
- Capacidad: 2450 lb

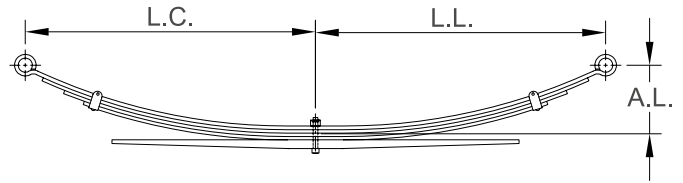



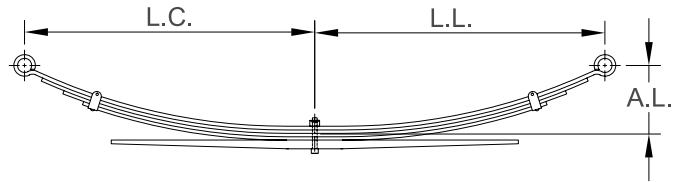

ANCHO	# HOJAS	CALIBRE	ARCO LIBRE	LONGITUD LADO CORTO	LONGITUD LADO LARGO	BUJE LADO CORTO	BUJE LADO LARGO	PUNTA LADO CORTO	PUNTA LADO LARGO
3	5 / .360	.360	6 7/8	24	31 1/2	RB132	RB133	 2	2 

KA43-559
FORD
Muelle Trasera

- Aplicación: F100-F150 Spring 1973-79
 - Modelo: 73-79
 - Capacidad: 1450 lb
- #Rassini: 43-559



ANCHO	# HOJAS	CALIBRE	ARCO LIBRE	LONGITUD LADO CORTO	LONGITUD LADO LARGO	BUJE LADO CORTO	BUJE LADO LARGO	PUNTA LADO CORTO	PUNTA LADO LARGO
2 1/2	5 / .323, .625	.323	7 5/8	24	31 1/2	RB131	RB131	 2	2 
	1A	.323	7 5/8	24	31 1/2	RB131	RB131	 2	2 

KA43-516
FORD
Muelle Delantera

- Aplicación: F350 2 Leaf Taper / Solid Ax
 - Capacidad: 2200 lb
- #Original: E5TZ5310K

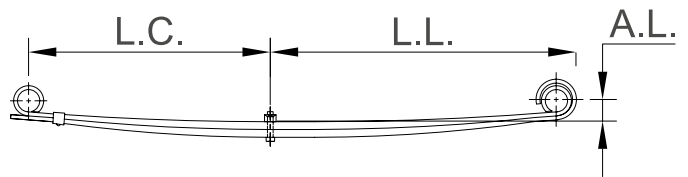

ANCHO	# HOJAS	CALIBRE	ARCO LIBRE	LONGITUD LADO CORTO	LONGITUD LADO LARGO	BUJE LADO CORTO	BUJE LADO LARGO	PUNTA LADO CORTO	PUNTA LADO LARGO
3	2 / .702, PD/.360	-	3	23 7/8	28 3/8	RB155	RB155	 1	1 

KA43-498

FORD

Muelle Delantera

- Aplicación: F250 2 Leaf Taper Spring
- Modelo: 80-98
- Capacidad: 3486 lb

#Original: E3TZ5310R

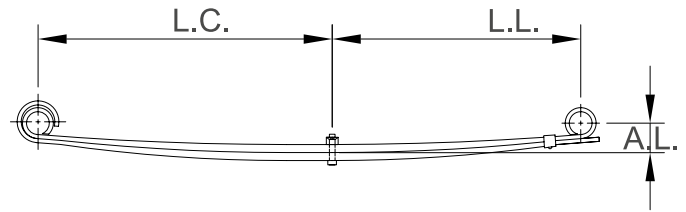

ANCHO	# HOJAS	CALIBRE	ARCO LIBRE	LONGITUD LADO CORTO	LONGITUD LADO LARGO	BUJE LADO CORTO	BUJE LADO LARGO	PUNTA LADO CORTO	PUNTA LADO LARGO
3	2 / .788	-	7/8	23 7/8	28 3/8	RB155	RB155	1	1
	3A	-	7/8	24 3/4	29 1/4	-	-		

KA43-490

FORD

Muelle Trasera

- Aplicación: F-Series Spring 4040
- Modelo: 94-98

#Original: E0HZ5310B
#Rassini: 12-380

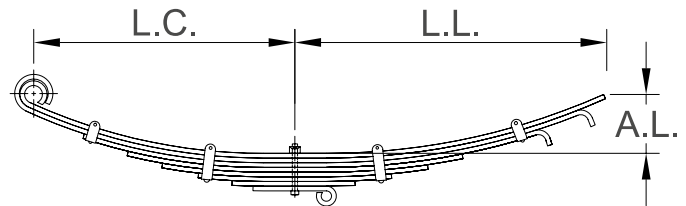

ANCHO	# HOJAS	CALIBRE	ARCO LIBRE	LONGITUD LADO CORTO	LONGITUD LADO LARGO	BUJE LADO CORTO	BUJE LADO LARGO	PUNTA LADO CORTO	PUNTA LADO LARGO
2 1/2	8 / .447	-	5 5/8	26	30 1/4	RB100	HK-2-3	1	21

KA43-478

FORD

Muelle Trasera

- Aplicación: F250 2 Leaf Taper Spring
- Modelo: 86-89,97

#Original: E0TZ5310S
#Rassini: 43-536

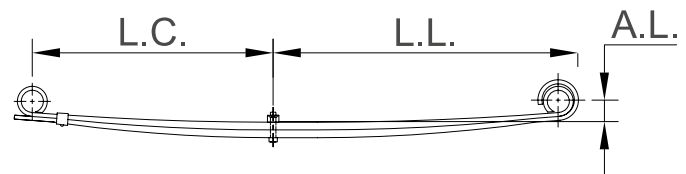

ANCHO	# HOJAS	CALIBRE	ARCO LIBRE	LONGITUD LADO CORTO	LONGITUD LADO LARGO	BUJE LADO CORTO	BUJE LADO LARGO	PUNTA LADO CORTO	PUNTA LADO LARGO
3	2 / .702	-	1 7/8	23 7/8	28 3/8	RB155	RB155	1	1

KA43-487-P









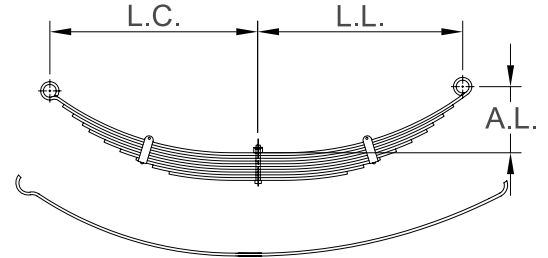











FORD

Muelle Trasera

- Aplicación: F3500 Doble Rodada 90-91
- Modelo: 67-92
- Capacidad: 2800 lb

#Original: C7TA-5560-AE
#Rassini: 13C-300



ANCHO	# HOJAS	CALIBRE	ARCO LIBRE	LONGITUD LADO CORTO	LONGITUD LADO LARGO	BUJE LADO CORTO	BUJE LADO LARGO	PUNTA LADO CORTO	PUNTA LADO LARGO
2 1/4	10 / .323,.360	.323	7 1/4	26	26	RB-101	RB-101	 2	1 
	1A	.323	7 1/4	26	26	RB-101	RB-101	 2	1 
	2A	.323	7 1/4	24 1/4	24 1/4	-	-	 10	10 
	2R	.323	7 1/4	26	26	-	-	 7A	10 
	3A	.323	7 1/4	23 1/4	23 1/4	-	-	 13	10 
	4A	.323	7 1/4	21 1/4	21 1/4	-	-	 10	10 
	5A	.323	7 1/4	19 1/4	19 1/4	-	-	 13	13 
	6A	.323	7 1/4	17	17	-	-	 10	10 
	7A	.323	7 1/4	14	14	-	-	 10	10 
	8A	.323	7 1/4	17	17	-	-	 10	10 

KA43-415

FORD

Muelle Trasera

- Aplicación: Leaf Springs gl Axle 14lvs

#Original: C3TZ5660V
#Rassini: 13-500-C

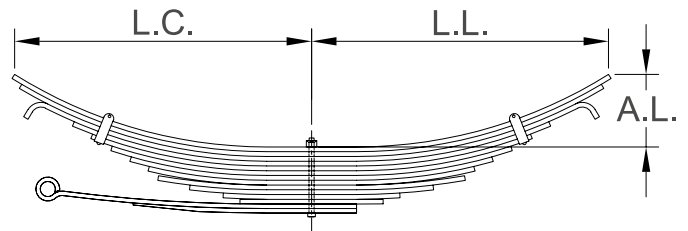

ANCHO	# HOJAS	CALIBRE	ARCO LIBRE	LONGITUD LADO CORTO	LONGITUD LADO LARGO	BUJE LADO CORTO	BUJE LADO LARGO	PUNTA LADO CORTO	PUNTA LADO LARGO
3	14 / .401,.499,.360,.447	-	7	29 5/8	28 3/8	-	-	 21	21 





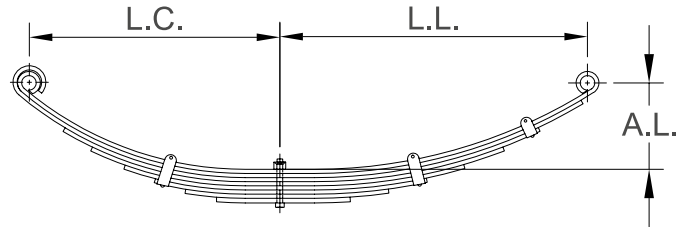

KA43-404

FORD

Muelle Delantera

- Aplicación: Camión Ford Delantera
- Capacidad: 7200 lb



ANCHO	# HOJAS	CALIBRE	ARCO LIBRE	LONGITUD LADO CORTO	LONGITUD LADO LARGO	BUJE LADO CORTO	BUJE LADO LARGO	PUNTA LADO CORTO	PUNTA LADO LARGO
4	10/.401	.401	7 5/8	23 7/8	28 3/8	NJK	NJK	 1	1 
	1A	.401	7 5/8	23 7/8	28 3/8	NJK	NJK	 1	1 
	2A	.401	7 5/8	23 7/8	27 3/8	-	-	 4	21 



KA43-390

FORD

Muelle Delantera

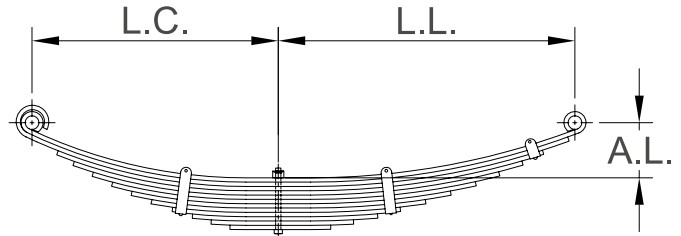
- Aplicación: L-Series Spring 9200
- Capacidad: 9200 lb



ANCHO	# HOJAS	CALIBRE	ARCO LIBRE	LONGITUD LADO CORTO	LONGITUD LADO LARGO	BUJE LADO CORTO	BUJE LADO LARGO	PUNTA LADO CORTO	PUNTA LADO LARGO
4	8 / .447, .401	-	5 1/4	23 7/8	28 3/8	NJK	NJK	 1	1 



KA43-388

FORD

Muelle Delantera

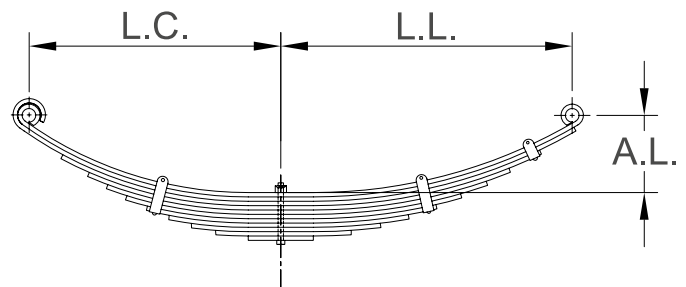
- Aplicación: L-Series Spring 7000
- Capacidad: 7200 lb



ANCHO	# HOJAS	CALIBRE	ARCO LIBRE	LONGITUD LADO CORTO	LONGITUD LADO LARGO	BUJE LADO CORTO	BUJE LADO LARGO	PUNTA LADO CORTO	PUNTA LADO LARGO
4	10 / .401	-	6 5/8	23 7/8	28 3/8	NJK	NJK	 1	1 

KA43-386

FORD

Muelle Delantera

- Aplicación: L-Series Spring 6000
- Capacidad: 6000 lb

#Original: DOHZ5310A

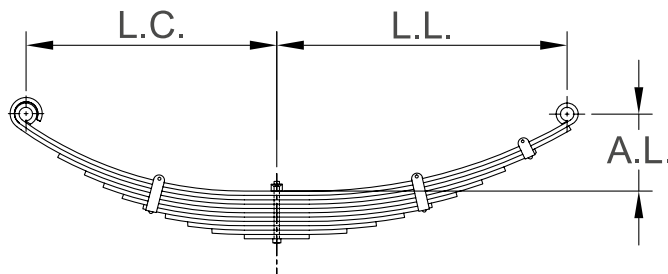

ANCHO	# HOJAS	CALIBRE	ARCO LIBRE	LONGITUD LADO CORTO	LONGITUD LADO LARGO	BUJE LADO CORTO	BUJE LADO LARGO	PUNTA LADO CORTO	PUNTA LADO LARGO
4	10 / .380,.360	-	7 1/8	23 7/8	28 3/8	NJK	NJK	 4	1 

KA43-377

FORD

Muelle Trasera

- Aplicación: Single Axle Spring 13000
- Modelo: 62-78

#Original: C3TZ5560D
#Rassini: 13-500-G

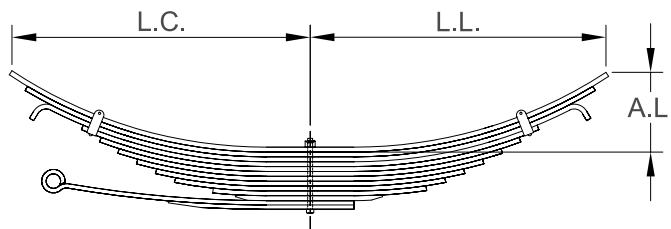

ANCHO	# HOJAS	CALIBRE	ARCO LIBRE	LONGITUD LADO CORTO	LONGITUD LADO LARGO	BUJE LADO CORTO	BUJE LADO LARGO	PUNTA LADO CORTO	PUNTA LADO LARGO
3	15 / .447,.360	-	6 7/8	29 3/4	29 3/4	HK-3	HK-3	 21	21 

KA43-358A-P

FORD

Muelle Delantera

- Aplicación: F-600, B-600, F-700
- Modelo: 80-83, 94

#Original: EQHT-5310-AA
#Rassini: 12-400

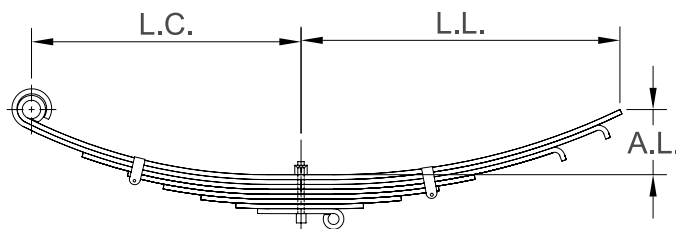

ANCHO	# HOJAS	CALIBRE	ARCO LIBRE	LONGITUD LADO CORTO	LONGITUD LADO LARGO	BUJE LADO CORTO	BUJE LADO LARGO	PUNTA LADO CORTO	PUNTA LADO LARGO
2 1/2	8 / .447	.447	8 1/2	26	30 1/4	RB100	-	 1	21 
	1A	.447	8 1/2	26	30 1/4	RB100	-	 1	21 
	2A	.447	8 1/2	26	28 3/4	-	-	 4	18 
	3A	.447	8 1/2	20 1/8	24 1/2	-	-	 13	11 
	3R	.447	8 1/2	24	26	-	-	 10	10 
	4A	.447	8 1/2	16 1/8	16 1/8	-	-	 10	10 
	5A	.447	8 1/2	12 3/4	12 3/4	-	-	 10	10 

KA43-358

FORD

Muelle Delantera

- Aplicación: Camión F-700, F-800
- Modelo: 67-79
- #Original: FAHT-5310-TA
- #Rassini: 12-380-A

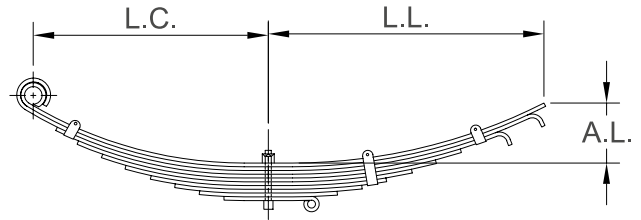

ANCHO	# HOJAS	CALIBRE	ARCO LIBRE	LONGITUD LADO CORTO	LONGITUD LADO LARGO	BUJE LADO CORTO	BUJE LADO LARGO	PUNTA LADO CORTO	PUNTA LADO LARGO
2 1/2	10 / .360	.360	5 3/4	24	27 5/16	RB100	-	1	21
	1A	-	5 3/4	24	27 5/16	RB100	-	1	21
	2A	-	5 3/4	24	25 1/8	-	-	4	11
	3A	-	5 3/4	21 1/2	23	-	-	13	11
	3R	-	5 3/4	24	24	-	-	10	10
	4A	-	5 3/4	19	19	-	-	10	10
	5A	-	5 3/4	16 3/8	16 3/8	-	-	10	10
	6A	-	5 3/4	13 3/4	13 3/4	-	-	10	10

KA43-349

FORD

Muelle Trasera

- Aplicación: B-600, F-600 c/Tirante
- Modelo: 62-78
- Capacidad: 6500 lb
- #Original: C2TA-5560
- #Rassini: 13-500-A

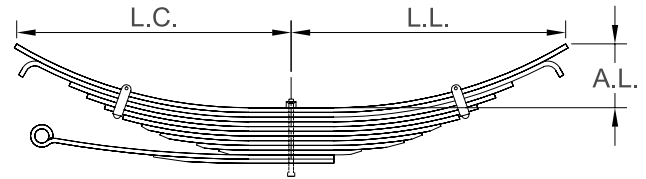

ANCHO	# HOJAS	CALIBRE	ARCO LIBRE	LONGITUD LADO CORTO	LONGITUD LADO LARGO	BUJE LADO CORTO	BUJE LADO LARGO	PUNTA LADO CORTO	PUNTA LADO LARGO
3	12 / .401, .447	.447	6 5/8	29 5/8	29 5/8	RNG	-	21	21
	SOBRE TIRANTE	.447	6 5/8	25 1/2	3 1/2	-	-	7	21
	1A	.401	6 5/8	29 5/8	29 5/8	-	-	21	21
	2A	.401	6 5/8	27 1/2	27 1/2	-	-	18	18
	2R	.401	6 5/8	26	26	-	-	10	10
	3A	.401	6 5/8	23	23	-	-	10	10
	3R	.401	6 5/8	24	24	-	-	10	10
	4A	.401	6 5/8	20 1/2	20 1/2	-	-	13	13
	4R	.401	6 5/8	21 1/2	21 1/2	-	-	10	10
	5A	.401	6 5/8	18 1/2	18 1/2	-	-	10	10
	6A	.401	6 5/8	15 3/4	15 3/4	-	-	10	10
	7A	.447	6 5/8	14 1/8	14 1/8	-	-	15	15
	8A	.447	6 5/8	10 3/4	10 3/4	-	-	15	15
	9A	.447	6 5/8	7 1/2	7 1/2	-	-	15	15
	11A	.447	6 5/8	25 1/2	3 1/2	RNG	-	2	21
	13A	.447	6 5/8	3 1/2	10 1/2	-	-	21	10

KA43-347-P





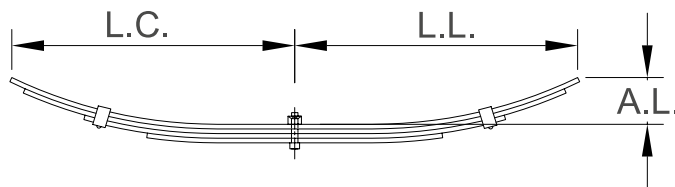

FORD

Muelle Trasera

- Aplicación: F-500, F-600
- Modelo: 62-88
- Capacidad: 2250 lb

#Original: BAQ-5588-A
#Rassini: 13-520



ANCHO	# HOJAS	CALIBRE	ARCO LIBRE	LONGITUD LADO CORTO	LONGITUD LADO LARGO	BUJE LADO CORTO	BUJE LADO LARGO	PUNTA LADO CORTO	PUNTA LADO LARGO
3	4 / .360	.360	3 3/4	19 1/2	19 1/2	-	-	 21	21 
	1A	-	3 3/4	19 1/2	19 1/2	-	-	 21	21 
	2A	-	3 3/4	15 1/2	15 1/2	-	-	 10	10 
	3A	-	3 3/4	13 1/2	13 1/2	-	-	 13	13 
	4A	-	-	8	8	-	-	 21	21 

KA43-293

FORD

Muelle Trasera

- Aplicación: F-100 2500 B-100
- Modelo: 65-78

#Original: C5TA-5560-C
#Rassini: 13C-240

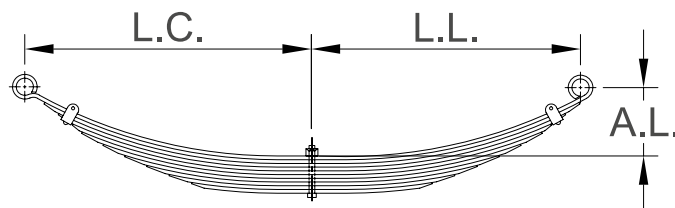

ANCHO	# HOJAS	CALIBRE	ARCO LIBRE	LONGITUD LADO CORTO	LONGITUD LADO LARGO	BUJE LADO CORTO	BUJE LADO LARGO	PUNTA LADO CORTO	PUNTA LADO LARGO
2 1/4	10 / .323	-	6 1/2	24	28	RB-52	RB-52	 2	1 
	1A	-	6 1/2	24	28	RB-52	RB-52	 2	1 
	2A	-	6 1/2	22	26	-	-	 10	10 
	3A	-	6 1/2	22	24	-	-	 17	10 

KA43-195



FORD

Muelle Trasera

- Aplicación: F250-350
- Modelo: 53-90
- Capacidad: 900 lb

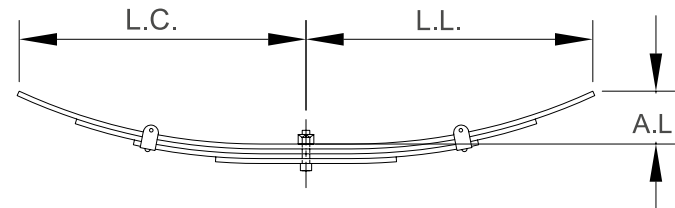
#Original: TCAA-5588-A
#Rassini: 13C-180



ANCHO	# HOJAS	CALIBRE	ARCO LIBRE	LONGITUD LADO CORTO	LONGITUD LADO LARGO	BUJE LADO CORTO	BUJE LADO LARGO	PUNTA LADO CORTO	PUNTA LADO LARGO
2 1/4	4 / .323	-	3 3/4	20 1/8	20 1/8	-	-	 21	21 
	1A	-	3 3/4	20 1/8	20 1/8	-	-	 21	21 
	2A	-	3 3/4	18 1/2	18 1/2	-	-	 10	10 
	3A	-	3 3/4	13 1/8	13 1/8	-	-	 13	13 
	4A	-	3 3/4	7 3/4	7 3/4	-	-	 13	13 

KA43-185

FORD

Muelle Trasera

- Aplicación: B-600, F-600
- Modelo: 80-90
- Capacidad: 2050 lb

#Original: BAQ-5588-A
#Rassini: 13-220

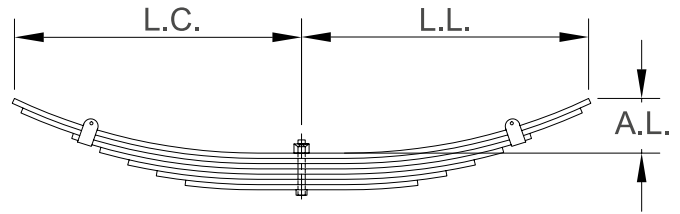

ANCHO	# HOJAS	CALIBRE	ARCO LIBRE	LONGITUD LADO CORTO	LONGITUD LADO LARGO	BUJE LADO CORTO	BUJE LADO LARGO	PUNTA LADO CORTO	PUNTA LADO LARGO
3	7 / .360	-	3 3/4	20 1/4	20 1/4	-	-	21	21
	1A	-	3 3/4	20 1/4	20 1/4	-	-	21	21
	2A	-	3 3/4	19 3/4	19 3/4	-	-	21	21
	3A	-	3 3/4	16	16	-	-	13	13

KA13-C340

FORD

Muelle Trasera

- Aplicación: F-150, B-150
- Modelo: 80-89
- Capacidad: 1020 lb

#Original: 82TY-5566-AA
#Rassini: 13C-340

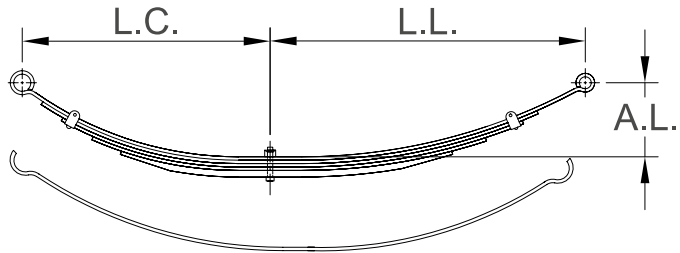

ANCHO	# HOJAS	CALIBRE	ARCO LIBRE	LONGITUD LADO CORTO	LONGITUD LADO LARGO	BUJE LADO CORTO	BUJE LADO LARGO	PUNTA LADO CORTO	PUNTA LADO LARGO
2 1/2	5 / .323,.625	323	7	25	31	RB150	1 1/8	2	2
	1A	323	7	25	31	RB150	1 1/8	2	2
	2A	323	7	22 3/4	26	-	-	10	10
	2R	323	7	25	31	-	-	7A	7A
	3A	323	7	20 1/2	24 1/2	-	-	13	13
	4A	323	7	17 1/4	20 3/4	-	-	10	10
	5A	625	7	14 1/2	17 1/2	-	-	15	15

KA43-2016T

FORD

Muelle

- Aplicación: Transit
- Modelo: 2016

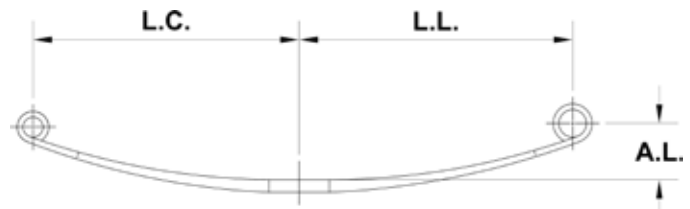

ANCHO	# HOJAS	CALIBRE	ARCO LIBRE	LONGITUD LADO CORTO	LONGITUD LADO LARGO	BUJE LADO CORTO	BUJE LADO LARGO	PUNTA LADO CORTO	PUNTA LADO LARGO
3	.625	-	26 1/2	27 3/8	ESP	ESP	-	1	1

KA48-887

FREIGHTLINER

Muelle Trasera

- Aplicación: 14 Leaf Single Axle Spring
- Capacidad: 9500 lb

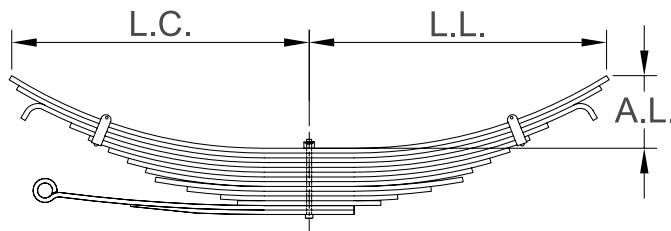

ANCHO	# HOJAS	CALIBRE	ARCO LIBRE	LONGITUD LADO CORTO	LONGITUD LADO LARGO	BUJE LADO CORTO	BUJE LADO LARGO	PUNTA LADO CORTO	PUNTA LADO LARGO
3	14 / .401, .499, .360, .447	-	77/8	29 5/8	29 5/8	-	-	21	21

KA46-1464

FREIGHTLINER

Muelle Delantera

- Aplicación: Century Columbia #Original: 59930-021
- Modelo: 01-06 #Rassini: 46-1464

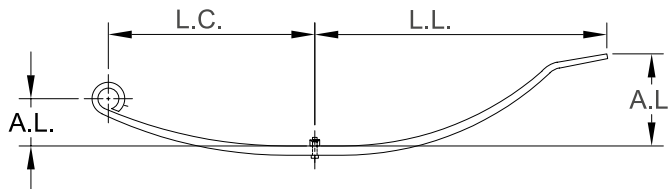

ANCHO	# HOJAS	CALIBRE	ARCO LIBRE	LONGITUD LADO CORTO	LONGITUD LADO LARGO	BUJE LADO CORTO	BUJE LADO LARGO	PUNTA LADO CORTO	PUNTA LADO LARGO
4	1 / .999	1	L.C. 3 7/8, L.L. 10 1/2	25 7/8	33	RB211	PATÍN	1	17
	1A	1	L.C. 3 7/8, L.L. 10 1/2	25 7/8	33	-	-	1	17
	2A	.788	L.C. 3 7/8, L.L. 10 1/2	25 7/8	33	-	-	4	10
	2A	.401	L.C. 3 7/8, L.L. 10 1/2	25 7/8	33	-	-	4	21

KA46-1462

FREIGHTLINER

Muelle Delantera

- Aplicación: Freightliner

#Original:
A16-16789-000
#Rassini: 46-1462-R

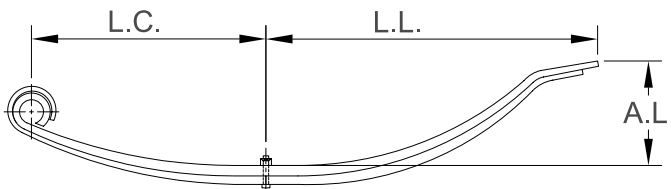

ANCHO	# HOJAS	CALIBRE	ARCO LIBRE	LONGITUD LADO CORTO	LONGITUD LADO LARGO	BUJE LADO CORTO	BUJE LADO LARGO	PUNTA LADO CORTO	PUNTA LADO LARGO
3	3 / 1, .401, .788	1	7 3/16	25 7/8	33	RB211	-	1	17
	1A	1	7 3/16	25 7/8	33	RB211	-	1	17
	2A	.401	7 3/16	26	28 3/4	-	-	4	10

KA46-1432-P





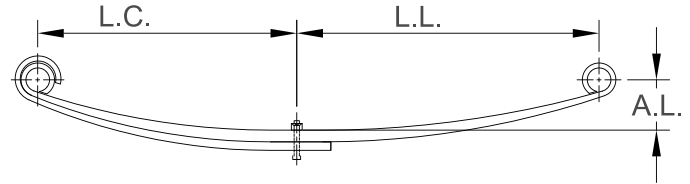

FREIGHTLINER

Muelle Delantera

- Aplicación: Freightliner Delantera
- Modelo: 91
- Capacidad: 6000 lb

#Original:
A1614898000



ANCHO	# HOJAS	CALIBRE	ARCO LIBRE	LONGITUD LADO CORTO	LONGITUD LADO LARGO	BUJE LADO CORTO	BUJE LADO LARGO	PUNTA LADO CORTO	PUNTA LADO LARGO
4	2 / 1"	1	5 1/6	26	30	RB233	RB233	 1	1 
	1A	1	5 1/6	26	30	RB233	RB233	 1	1 
	2A	1	5 1/6	26	30	-	-	 4	9 

KA46-1418





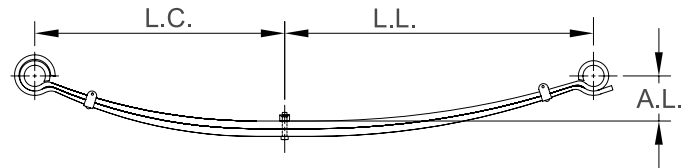

FREIGHTLINER

Muelle Delantera

- Aplicación: 2 Leaf 4.0k With Rb256
- Capacidad: 4000 lb

#Rassini: 46-1244



ANCHO	# HOJAS	CALIBRE	ARCO LIBRE	LONGITUD LADO CORTO	LONGITUD LADO LARGO	BUJE LADO CORTO	BUJE LADO LARGO	PUNTA LADO CORTO	PUNTA LADO LARGO
3	2 / .788	.788	4 15/16	27 15/16	31 1/8	RB212	RB212	 2	2 
	1A	.788	4 15/16	27 15/16	31 1/8	RB212	RB212	 2	2 
	2A	.788	4 15/16	27 15/16	31 1/8	-	-	 7	8 





KA46-1309

FREIGHTLINER

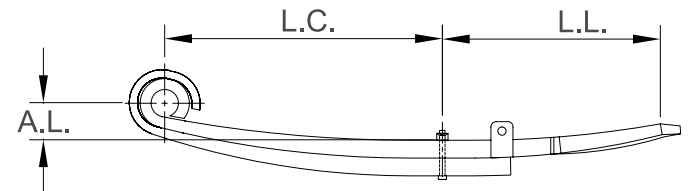
Muelle Trasera

- Aplicación: Freightliner Air Leaf - RhS



ANCHO	# HOJAS	CALIBRE	ARCO LIBRE	LONGITUD LADO CORTO	LONGITUD LADO LARGO	BUJE LADO CORTO	BUJE LADO LARGO	PUNTA LADO CORTO	PUNTA LADO LARGO
3	2 / 1.625, 1.375	-	-	25 1/2	18 1/2	RB268	-	 1	17 
	1A	-	-	28 1/2	18 1/2	-	-	 1	17 







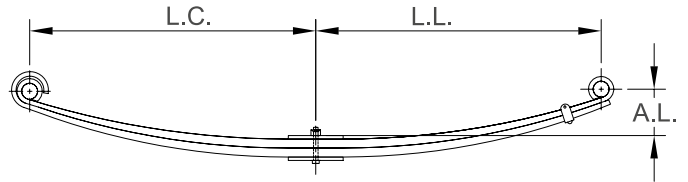

KA46-1406-P

FREIGHTLINER

Muelle Delantera

- Aplicación: Freightliner
- Modelo: 91
- Capacidad: 5500 lb



ANCHO	# HOJAS	CALIBRE	ARCO LIBRE	LONGITUD LADO CORTO	LONGITUD LADO LARGO	BUJE LADO CORTO	BUJE LADO LARGO	PUNTA LADO CORTO	PUNTA LADO LARGO
4	2 / .788	.788	5 3/8	26 1/4	28 3/4	RB233	RB233	 1	1 
	1A	.788	5 3/8	26 1/4	28 3/4	RB233	RB233	 1	1 
	2A	.788	5 3/8	26 1/4	30	-	-	 4	9 
	TACON	.401	5 3/8	3	3	-	-	 21	21 

KA46-1319

FREIGHTLINER

Muelle Trasera

- Aplicación: 7 Leaf M2 Rear Spring 23.0k
- Capacidad: 10600 lb

#Original: A1614463000
#Rassini: 39-626

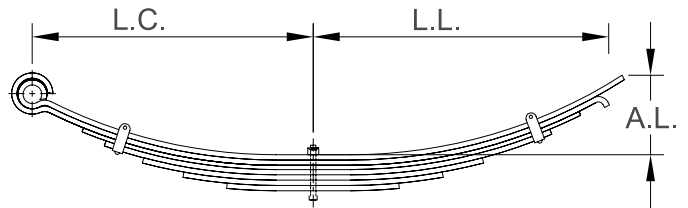

ANCHO	# HOJAS	CALIBRE	ARCO LIBRE	LONGITUD LADO CORTO	LONGITUD LADO LARGO	BUJE LADO CORTO	BUJE LADO LARGO	PUNTA LADO CORTO	PUNTA LADO LARGO
3	7 / .788	.788	4	26 1/4	26 1/4	RB267	-	 2	21 
	1A	.788	4	26 1/4	26 1/4	-	-	 2	21 
	2A	.788	4	26 1/4	26 1/4	-	-	 7	18 



KA46-1307

FREIGHTLINER

Muelle Delantera

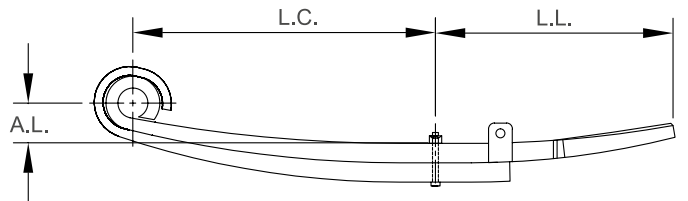
- Aplicación: Airliner Ii Support Beam Lhs



ANCHO	# HOJAS	CALIBRE	ARCO LIBRE	LONGITUD LADO CORTO	LONGITUD LADO LARGO	BUJE LADO CORTO	BUJE LADO LARGO	PUNTA LADO CORTO	PUNTA LADO LARGO
3	2 / 1.625, 1.375	1.625	-	25 1/2	18 1/2	RB268	-	 1	17 
	1A	1.625	-	25 1/2	18 1/2	-	-	 1	17 

KA46-1302-P

FREIGHTLINER

Muelle Delantera

- Aplicación: 2 Leaf Spring Rb211 / Rb211
- Modelo: 96-2000
- Capacidad: 5400 lb

#Original:
A1614463000

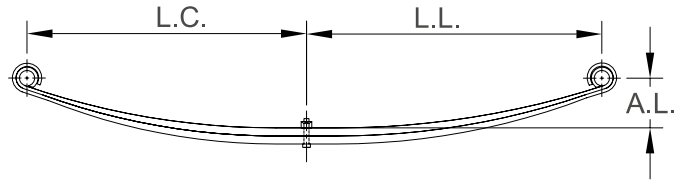

ANCHO	# HOJAS	CALIBRE	ARCO LIBRE	LONGITUD LADO CORTO	LONGITUD LADO LARGO	BUJE LADO CORTO	BUJE LADO LARGO	PUNTA LADO CORTO	PUNTA LADO LARGO
4	2 / .788	.788	5 7/8	26 1/8	30	RB233	RB233	1	1
	1A	.788	5 7/8	26 1/8	30	-	-	1	1
	2A	.788	5 7/8	26 1/8	30	-	-	4	4

KA46-1280

FREIGHTLINER

Muelle Delantera

- Aplicación: Freightliner
- Modelo: 91
- Capacidad: 5500 lb

#Original:
A1613412001

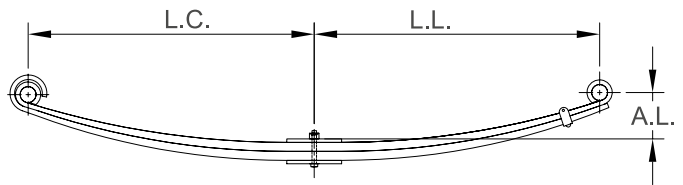

ANCHO	# HOJAS	CALIBRE	ARCO LIBRE	LONGITUD LADO CORTO	LONGITUD LADO LARGO	BUJE LADO CORTO	BUJE LADO LARGO	PUNTA LADO CORTO	PUNTA LADO LARGO
4	3 / .788	.788	6 5/16	26 1/8	29	RNK	RNK	1	1
	1A	.788	6 5/16	26 1/8	29	RNK	RNK	1	1
	2A	.788	6 5/16	26 1/8	30	-	-	4	9
	TACON	.788	6 5/16	3	3	-	-	21	21
	TACON	.788	6 5/16	3	3	-	-	21	21

KA46-1246-P

FREIGHTLINER

Muelle Delantera

- Aplicación: Freightliner
- Modelo: 98-200
- Capacidad: 5400 lb

#Original:
6803200302

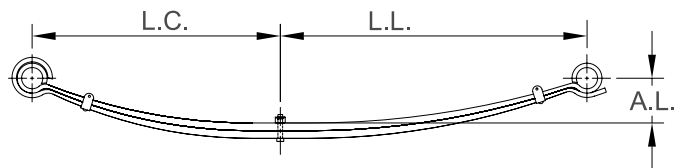



ANCHO	# HOJAS	CALIBRE	ARCO LIBRE	LONGITUD LADO CORTO	LONGITUD LADO LARGO	BUJE LADO CORTO	BUJE LADO LARGO	PUNTA LADO CORTO	PUNTA LADO LARGO
4	2 / .788	-	4 3/4	27 15/16	32 1/2	RB233	RB233	2	2
	1A	-	4 3/4	27 15/16	32 1/2	RB233	RB233	2	2
	2A	-	4 3/4	27 15/16	32 1/2	-	-	7	8

KA46-1242
FREIGHTLINER
Muelle Delantera

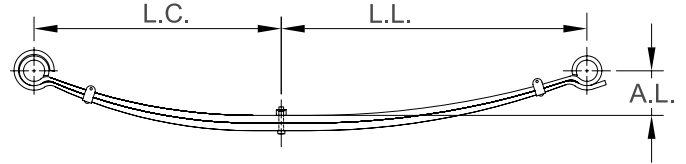
- Aplicación: 2 Leaf 4,000 With Rb212 B.E, Chasis 1217I Camión Urbano
 - Modelo: 99-05
 - Capacidad: 4000 lb
- #Original: 6803200102





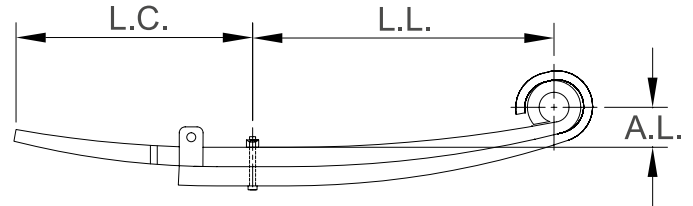

ANCHO	# HOJAS	CALIBRE	ARCO LIBRE	LONGITUD LADO CORTO	LONGITUD LADO LARGO	BUJE LADO CORTO	BUJE LADO LARGO	PUNTA LADO CORTO	PUNTA LADO LARGO
3	2 / .788	-	49/16	27 15/16	31 1/8	RB212-B	RB212-B	 2	2 

KA46-1217
FREIGHTLINER
Muelle Trasera

- Aplicación: Freightliner Air Leaf Lhs/R
 - Modelo: 2001
- #Original: A1613997000



ANCHO	# HOJAS	CALIBRE	ARCO LIBRE	LONGITUD LADO CORTO	LONGITUD LADO LARGO	BUJE LADO CORTO	BUJE LADO LARGO	PUNTA LADO CORTO	PUNTA LADO LARGO
3	2 / 1.625	-	2 5/16	25 3/4	20	RB234	RB-205	 1	21 
	1A	-	-	-	-	-	-	 1	21 

KA46-1197
FREIGHTLINER
Muelle Trasera

- Aplicación: Freightliner Single Leaf, Tipo Revolvedora
 - Modelo: 2000
 - Capacidad: 4615 lb
- #Original: 6803200105

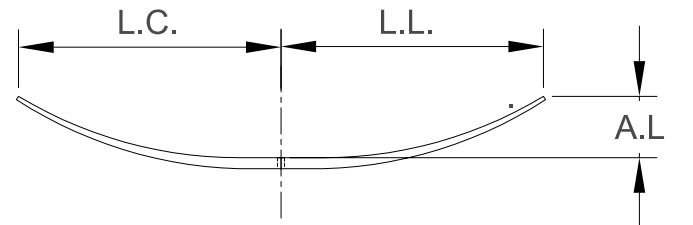

ANCHO	# HOJAS	CALIBRE	ARCO LIBRE	LONGITUD LADO CORTO	LONGITUD LADO LARGO	BUJE LADO CORTO	BUJE LADO LARGO	PUNTA LADO CORTO	PUNTA LADO LARGO
3	1 / .788	.788	2 3/4	19 1/4	19 1/4	-	-	 21	21 

KA46-1189

FREIGHTLINER

Muelle Trasera

- Aplicación: Freightliner
- Modelo: 2000
- Capacidad: 10150 lb

#Original: 6803200005
#Rassini: 46-1193

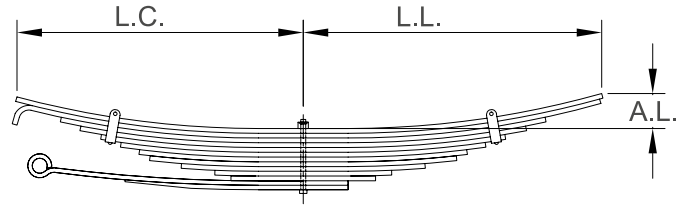

ANCHO	# HOJAS	CALIBRE	ARCO LIBRE	LONGITUD LADO CORTO	LONGITUD LADO LARGO	BUJE LADO CORTO	BUJE LADO LARGO	PUNTA LADO CORTO	PUNTA LADO LARGO
3	13 / .590, .499, .360, .447	.625	3 1/2	29 1/2	29 1/2	-	-	21	21
	1A	.625	3 1/2	29 1/2	29 1/2	-	-	21	21
	2A	.625	3 1/2	29 5/8	29 5/8	-	-	21	21
	3A	.625	3 1/2	22 3/8	22 3/8	-	-	21	21
	4A	.625	3 1/2	19 1/16	19 1/16	-	-	13	13
	5A	.625	3 1/2	15 7/8	15 7/8	-	-	10	10

KA46-220-P

FREIGHTLINER

Muelle Delantera

- Aplicación: Muelle Delantera
- Capacidad: 5500 lb

#Original: A1612612
#Rassini: 41-140-E

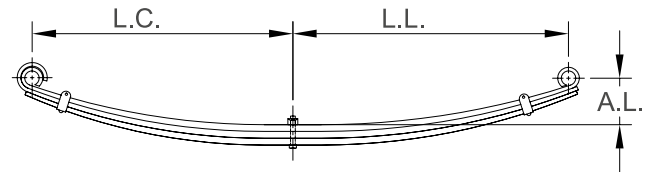

ANCHO	# HOJAS	CALIBRE	ARCO LIBRE	LONGITUD LADO CORTO	LONGITUD LADO LARGO	BUJE LADO CORTO	BUJE LADO LARGO	PUNTA LADO CORTO	PUNTA LADO LARGO
4	3 / .625	.625	7 1/2	26 3/16	28 7/8	RNK	RNK	1	1
	1A	.625	7 1/2	26 3/16	28 7/8	RNK	RNK	1	1
	2A	.625	7 1/2	26 3/16	28 7/8	-	-	4	9
	3A	.625	7 1/2	26 3/16	28 7/8	-	-	9	9

KA59-824FL

FREIGHTLINER

Muelle Delantera

- Aplicación: Century Columbia
- Modelo: 2001-2006

#Original: 59930-021

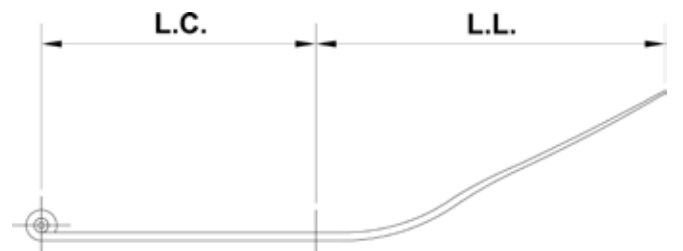

ANCHO	# HOJAS	CALIBRE	ARCO LIBRE	LONGITUD LADO CORTO	LONGITUD LADO LARGO	BUJE LADO CORTO	BUJE LADO LARGO	PUNTA LADO CORTO	PUNTA LADO LARGO
3	1	-	ESP	25 3/8	40 3/4	DT1604	-	1	ESP





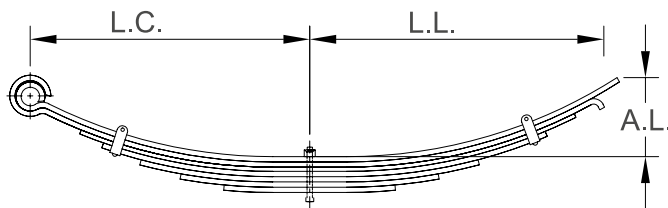

KA39-626

FREIGHTLINER

Muelle Trasera

- Aplicación: Camión Trasera



ANCHO	# HOJAS	CALIBRE	ARCO LIBRE	LONGITUD LADO CORTO	LONGITUD LADO LARGO	BUJE LADO CORTO	BUJE LADO LARGO	PUNTA LADO CORTO	PUNTA LADO LARGO
3	7 / .625	.625	5 3/8	26 1/8	30 1/2	RB267	-	 2	21 
	1A	.625	5 3/8	26 1/8	30 1/2	2 1/16	-	 2	21 
	2A	.625	5 3/8	26 1/8	30 1/2	-	-	 7	18 
	3A	.625	5 3/8	22	24	-	-	 10	10 
	4A	.625	5 3/8	19	21	-	-	 13	13 

KA46-151-P

FREIGHTLINER

Muelle Trasera

- Aplicación: Freightliner #Original: A16-12853
- Modelo: 89 #Rassini: 46-151

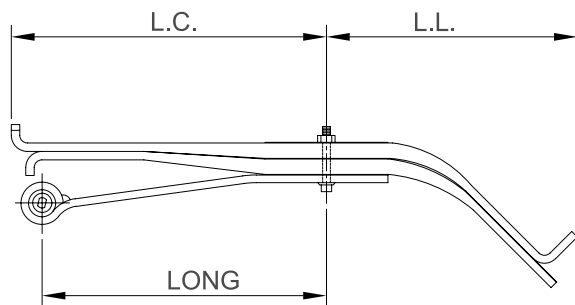



ANCHO	# HOJAS	CALIBRE	ARCO LIBRE	LONGITUD LADO CORTO	LONGITUD LADO LARGO	BUJE LADO CORTO	BUJE LADO LARGO	PUNTA LADO CORTO	PUNTA LADO LARGO
4	2 / .999	.999	ESPECIAL	20 1/2	16 15/16	-	-	 18	18 
	TIRANTE	.499	ESPECIAL	-	-	RB175	-	 2	21 
	1A	.999	ESPECIAL	20 1/2	16 15/16	-	-	 18	18 
	2A	.999	ESPECIAL	19 9/16	16 15/16	-	-	 18	21 

KA39-626A

FREIGHTLINER

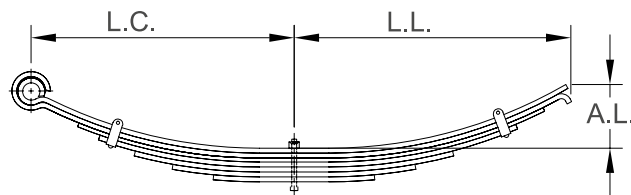
Muelle Delantera



ANCHO	# HOJAS	CALIBRE	ARCO LIBRE	LONGITUD LADO CORTO	LONGITUD LADO LARGO	BUJE LADO CORTO	BUJE LADO LARGO	PUNTA LADO CORTO	PUNTA LADO LARGO
3	7 / .625	.625	5 3/8	26 1/8	30 1/2	RB267	-	 2	21 
	1A	.625	5 3/8	26 1/8	30 1/2	RB267	-	 2	21 
	2A	.625	5 3/8	22	24	-	-	 7	18 

KA71-145C-P

FRUEHAUF

Muelle Trasera

- Aplicación: Caja Baja
- Modelo: 93-98
- #Original: USM-4185-001
- #Rassini: 71-145-C

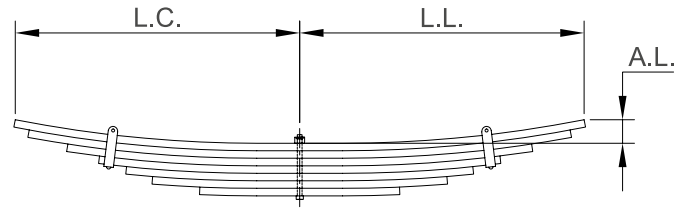

ANCHO	# HOJAS	CALIBRE	ARCO LIBRE	LONGITUD LADO CORTO	LONGITUD LADO LARGO	BUJE LADO CORTO	BUJE LADO LARGO	PUNTA LADO CORTO	PUNTA LADO LARGO
5	7 / .788	.788	2 1/2	30 1/2	30 1/2	-	-	13	13
	1A	.788	2 1/2	30 1/2	30 1/2	-	-	13	13
	2A	.788	2 1/2	30 1/2	30 1/2	-	-	21	21
	3A	.788	2 1/2	19 1/2	19 1/2	-	-	13	13
	4A	.788	2 1/2	15 1/2	15 1/2	-	-	21	21
	5A	.788	2 1/2	11	11	-	-	21	21

KATRA-2172

FRUEHAUF

Muelle Trasera

- Aplicación: Caja Susp. F1, F2,S1,S2
- Modelo: 66-94
- Capacidad: 10500 lb
- #Original: USM-0552
- #Rassini: 71-145

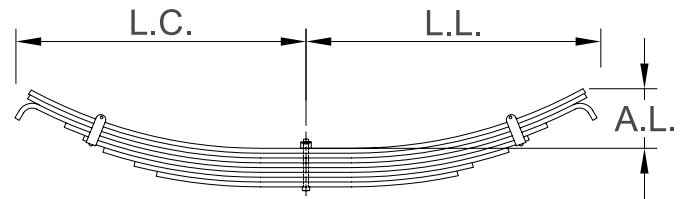

ANCHO	# HOJAS	CALIBRE	ARCO LIBRE	LONGITUD LADO CORTO	LONGITUD LADO LARGO	BUJE LADO CORTO	BUJE LADO LARGO	PUNTA LADO CORTO	PUNTA LADO LARGO
3	8 / .499	-	2 1/2	20 5/8	20 5/8	-	-	10	10
	1A	-	2 1/2	20 5/8	20 5/8	-	-	10	10
	2A	-	2 1/2	21	21	-	-	18	18
	3A	-	2 1/2	17 1/4	17 1/4	-	-	10	10
	3R	-	2 1/2	19	19	-	-	10	10
	4A	-	2 1/2	16 1/4	16 1/4	-	-	10	10
	5A	-	2 1/2	14	14	-	-	13	10
	6A	-	2 1/2	11	11	-	-	10	10
	7A	-	2 1/2	9	9	-	-	10	10
8A	-	2 1/2	6	6	-	-	21	21	

KATRA-699



FRUEHAUF

Muelle Trasera

- Aplicación: Muelle Tipo Tandem
- Capacidad: 11000 lb

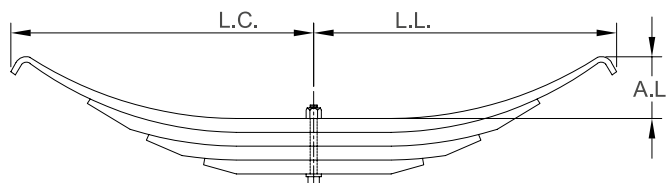
#Original: UCB0201
#Rassini: TRA-699



ANCHO	# HOJAS	CALIBRE	ARCO LIBRE	LONGITUD LADO CORTO	LONGITUD LADO LARGO	BUJE LADO CORTO	BUJE LADO LARGO	PUNTA LADO CORTO	PUNTA LADO LARGO
3	4 / .788	.788	4 1/4	21 1/2	21 1/2	-	-	 11	11 
	1A	.788	4 1/4	21 1/2	21 1/2	-	-	 11	11 
	2A	.788	4 1/4	16 3/8	16 3/8	-	-	 15	15 
	3A	-	4 1/4	14 1/2	14 1/2	-	-	 15	15 
	4A	-	4 1/4	9 1/4	9 1/4	-	-	 15	15 

KATRA-697

FRUEHAUF

Muelle Trasera

- Aplicación: Fruehauf 3 Leaf Spring
- Capacidad: 8500 lb

#Original:
UAC007981-001

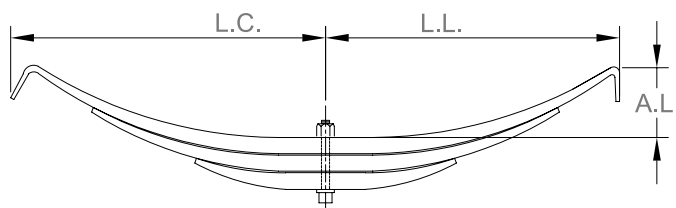

ANCHO	# HOJAS	CALIBRE	ARCO LIBRE	LONGITUD LADO CORTO	LONGITUD LADO LARGO	BUJE LADO CORTO	BUJE LADO LARGO	PUNTA LADO CORTO	PUNTA LADO LARGO
3	3 / .788	-	1 1/2	21 5/16	21 5/16	-	-	 11	11 

KATRA-693





FRUEHAUF

Muelle Trasera

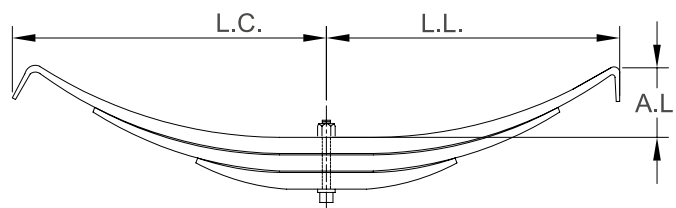
- Aplicación: Fruehauf 3 Leaf Spring
- Capacidad: 8500 lb

#Original:
UCD0511-1



ANCHO	# HOJAS	CALIBRE	ARCO LIBRE	LONGITUD LADO CORTO	LONGITUD LADO LARGO	BUJE LADO CORTO	BUJE LADO LARGO	PUNTA LADO CORTO	PUNTA LADO LARGO
3	3 / .788	.788	4 1/8	21 1/2	21 1/2	-	-	 11	11 
	1A	.788	4 1/8	21 1/2	21 1/2	-	-	 11	11 

KATRA-086

FRUEHAUF

Muelle Trasera

- Aplicación: Fruehauf
- Capacidad: 14500 lb

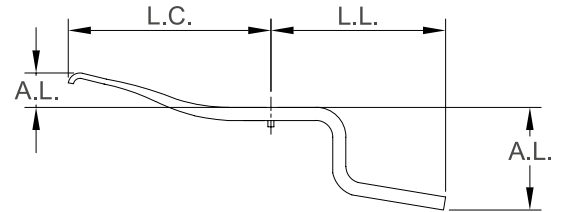

ANCHO	# HOJAS	CALIBRE	ARCO LIBRE	LONGITUD LADO CORTO	LONGITUD LADO LARGO	BUJE LADO CORTO	BUJE LADO LARGO	PUNTA LADO CORTO	PUNTA LADO LARGO
3	1 / 1.750	1.750	ESPECIAL	21 1/4	20 11/16	-	-	11	17

KATRA-081

FRUEHAUF

Muelle Trasera

- Aplicación: Fruehauf R.H. Trailing Arm

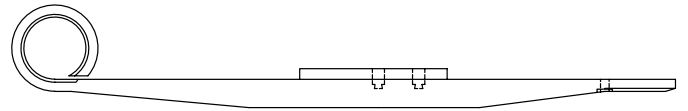

ANCHO	# HOJAS	CALIBRE	ARCO LIBRE	LONGITUD LADO CORTO	LONGITUD LADO LARGO	BUJE LADO CORTO	BUJE LADO LARGO	PUNTA LADO CORTO	PUNTA LADO LARGO
4 1/2	2 / 1.750,499	-	-	20	19 7/8	HK-1	-	13	1

KATRA-020

FRUEHAUF

Muelle Trasera

- Aplicación: Fruehauf L.H. Trailing Arm 110 Ea

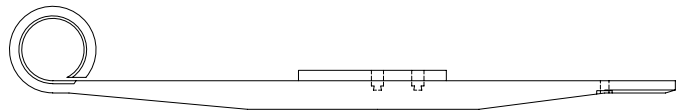

ANCHO	# HOJAS	CALIBRE	ARCO LIBRE	LONGITUD LADO CORTO	LONGITUD LADO LARGO	BUJE LADO CORTO	BUJE LADO LARGO	PUNTA LADO CORTO	PUNTA LADO LARGO
4 1/2	2 / 1.750,499	-	-	20	19 7/8	3	-	13	1

KA48-921

GM

Muelle Trasera

- Aplicación: Helper Spring Single Leaf #Original: 660130
- Capacidad: 2250 lb

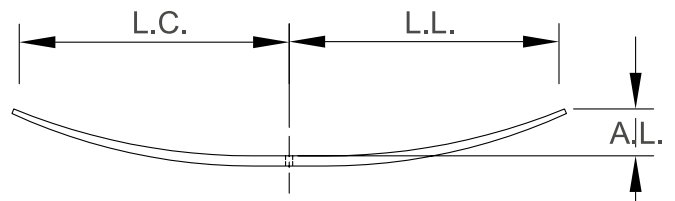

ANCHO	# HOJAS	CALIBRE	ARCO LIBRE	LONGITUD LADO CORTO	LONGITUD LADO LARGO	BUJE LADO CORTO	BUJE LADO LARGO	PUNTA LADO CORTO	PUNTA LADO LARGO
3	1 / .702	-	3 1/4	19 1/2	19 1/2	-	-	16	16

KA39-029

GM

Muelle Trasera

- Aplicación: Camión Urbano Casa-Bus Parabólica
- Modelo: 1995

#Rassini: 81-170

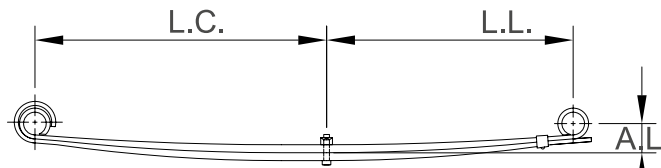

ANCHO	# HOJAS	CALIBRE	ARCO LIBRE	LONGITUD LADO CORTO	LONGITUD LADO LARGO	BUJE LADO CORTO	BUJE LADO LARGO	PUNTA LADO CORTO	PUNTA LADO LARGO
3	2 / .788	.788	3	28	30	RNG	RNG	 1	1 
	1A	.788	3	28	30	RNG	RNG	 1	1 
	2A	.788	3	28	30	-	-	 4	9 

KA22-1531

GM





Muelle Trasera

- Aplicación: Pick Up Cheyene
- Modelo: 2006
- Capacidad: 2600 lb

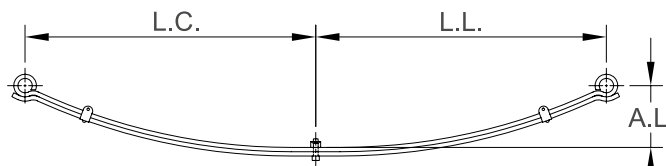
#Original: CT-033

#Rassini: 22-1269



ANCHO	# HOJAS	CALIBRE	ARCO LIBRE	LONGITUD LADO CORTO	LONGITUD LADO LARGO	BUJE LADO CORTO	BUJE LADO LARGO	PUNTA LADO CORTO	PUNTA LADO LARGO
2 1/2	2 / .447	.477	5 3/4	32	32	RB250	RB172	 2	2 
	1A	.401	5 3/4	32	32	RB250	RB172	 2	2 
	2R	.401	5 3/4	32	32	-	-	 7A	7A 

KA22-1289

GM

Muelle Trasera

- Aplicación: 6 Leaf Main Spring
- Modelo: 99-2010

#Original:

15063185

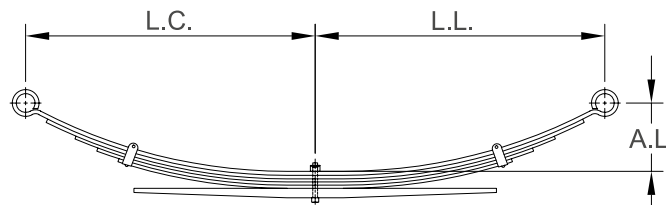

ANCHO	# HOJAS	CALIBRE	ARCO LIBRE	LONGITUD LADO CORTO	LONGITUD LADO LARGO	BUJE LADO CORTO	BUJE LADO LARGO	PUNTA LADO CORTO	PUNTA LADO LARGO
2 1/2	6 / .423, .380, .360, .999	-	7 1/4	32	32	RB250-B	RB250-B	 2	2 

KA22-1271

GM

Muelle Trasera

- Aplicación: Silverado 1500
3 Leaf Spring
- Modelo: 99-06

#Original: 15746328
#Rassini: 22-1221

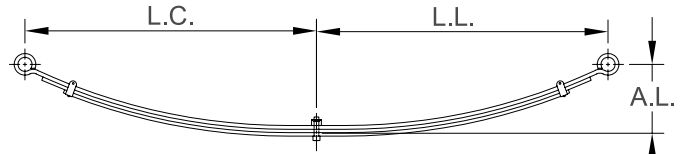

ANCHO	# HOJAS	CALIBRE	ARCO LIBRE	LONGITUD LADO CORTO	LONGITUD LADO LARGO	BUJE LADO CORTO	BUJE LADO LARGO	PUNTA LADO CORTO	PUNTA LADO LARGO
2 1/2	3 / .401,.423,.750	-	7 1/4	32	32	RB250-B	RB250-B	2	2

KA22-1269

GM

Muelle Trasera

- Aplicación: Silverado 2500 Spring
- Modelo: 2000-2010
- Capacidad: 2200 lb

#Original: 15711753
#Rassini: 23C-400

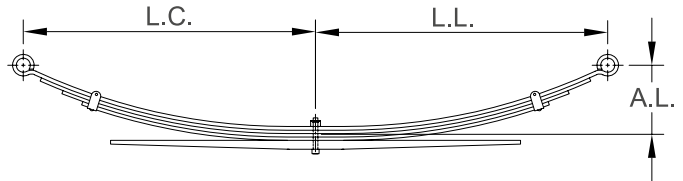

ANCHO	# HOJAS	CALIBRE	ARCO LIBRE	LONGITUD LADO CORTO	LONGITUD LADO LARGO	BUJE LADO CORTO	BUJE LADO LARGO	PUNTA LADO CORTO	PUNTA LADO LARGO
2 1/2	5 / .401,.380,.360,.999	-	6 1/2	32	32	RB250-B	RB172-B	2	2

KA22-909

GM

Muelle Trasera

- Aplicación: Silverado
- Modelo: 89-94
- Capacidad: 1126 lb

#Original: 15028068
#Rassini: 23C-430

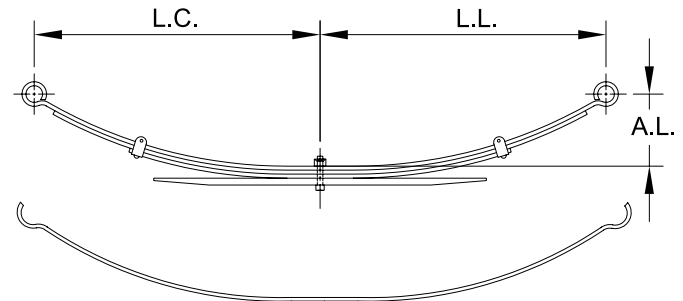

ANCHO	# HOJAS	CALIBRE	ARCO LIBRE	LONGITUD LADO CORTO	LONGITUD LADO LARGO	BUJE LADO CORTO	BUJE LADO LARGO	PUNTA LADO CORTO	PUNTA LADO LARGO
2 1/2	4 / .360	-	6 1/2	27	27	RB-117	RB-117	2	2
	1A	.360	6 1/2	27	27	RB-117	RB-117	2	2
	2A	.360	6 1/2	25	25	-	-	10	10
	2R	.360	6 1/2	27	27	-	-	7A	7A
	3A	.360	6 1/2	17 1/2	17 1/2	-	-	13	13

KA22-905









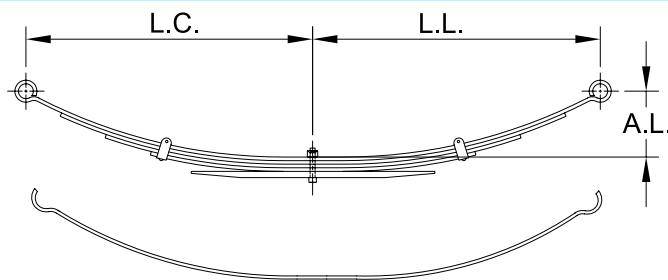

GM

Muelle Trasera

- Aplicación: Muelle Trasera Suburban
- Modelo: 81-91
- Capacidad: 2235 lb

#Original: 15030575
#Rassini: 23C-400-C



ANCHO	# HOJAS	CALIBRE	ARCO LIBRE	LONGITUD LADO CORTO	LONGITUD LADO LARGO	BUJE LADO CORTO	BUJE LADO LARGO	PUNTA LADO CORTO	PUNTA LADO LARGO
2 1/2	5 / .360, .447	-	6	30	30	RB-117	RB-117	 2	2 
	1A	.360	6	30	30	RB-117	RB-117	 2	2 
	2A	.360	6	26 1/8	26 1/8	-	-	 10	10 
	2R	.360	6	30	30	-	-	 7A	7A 
	3A	.447	6	21 1/4	21 1/4	-	-	 10	10 

KA22-851









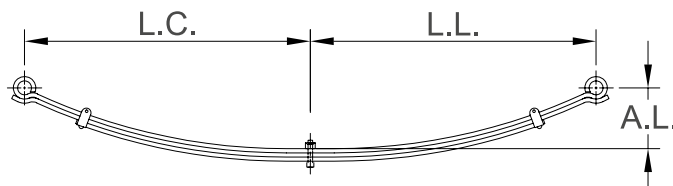

GM

Muelle Trasera

- Aplicación: Camión Chev Trasero
- Modelo: 2000

#Original: 15604179
#Rassini: 23C-401-F



ANCHO	# HOJAS	CALIBRE	ARCO LIBRE	LONGITUD LADO CORTO	LONGITUD LADO LARGO	BUJE LADO CORTO	BUJE LADO LARGO	PUNTA LADO CORTO	PUNTA LADO LARGO
2 1/2	3 / .447	-	6 1/2	32	32	RB-117	RB-117	 2	2 
	1A	.447	6 1/2	32	32	RB-117	RB-117	 2	2 
	2A	.447	6 1/2	32	32	-	-	 10	10 
	2R	.447	6 1/2	32	32	-	-	 7A	7A 
	3A	.447	6 1/2	26	26	-	-	 13	13 

KA22-845







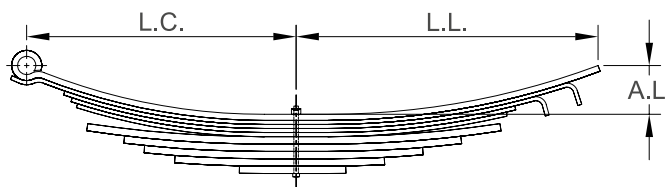

GM

Muelle Trasera

- Aplicación: Camión Kodiak Trasera
- Modelo: 1997
- Capacidad: 10250 lb

#Original: 93426549
#Rassini: 22845



ANCHO	# HOJAS	CALIBRE	ARCO LIBRE	LONGITUD LADO CORTO	LONGITUD LADO LARGO	BUJE LADO CORTO	BUJE LADO LARGO	PUNTA LADO CORTO	PUNTA LADO LARGO
3	10 / .625, .447	-	5 3/8	29 13/16	33 3/8	RB-191	-	 2	21 
	1A	.625	5 3/8	29 13/16	33 3/8	RB-191	-	 2	21 
	2A	.447	5 3/8	29 13/16	31 1/8	-	-	 7	18 
	3A	.447	5 3/8	24	26	-	-	 21	18 

KA22-837

GM

Muelle Trasera

- Aplicación: Topkick Helper Spring 2000
- Modelo: 90-09
- Capacidad: 2000 lb

#Original: 15574842

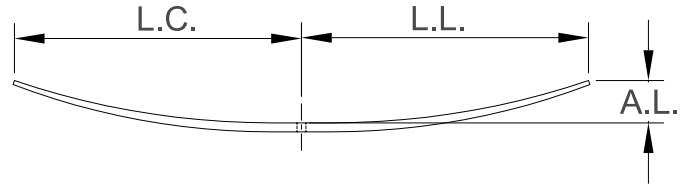

ANCHO	# HOJAS	CALIBRE	ARCO LIBRE	LONGITUD LADO CORTO	LONGITUD LADO LARGO	BUJE LADO CORTO	BUJE LADO LARGO	PUNTA LADO CORTO	PUNTA LADO LARGO
3	1 / .625	-	3 1/2	24 5/8	24 5/8	-	-	16	16
	1A	.625	3 1/2	24 5/8	24 5/8	-	-	16	16

KA22-835

GM

Muelle Trasera

- Aplicación: Camión Kodiak Trasera
- Modelo: 2000
- Capacidad: 10267 lb

#Original: 15641030 #Rassini: 22-921

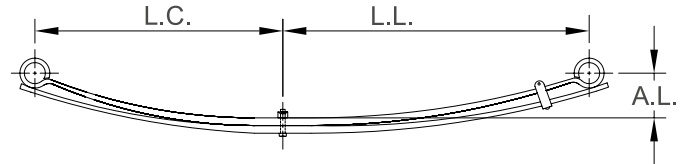

ANCHO	# HOJAS	CALIBRE	ARCO LIBRE	LONGITUD LADO CORTO	LONGITUD LADO LARGO	BUJE LADO CORTO	BUJE LADO LARGO	PUNTA LADO CORTO	PUNTA LADO LARGO
3	3 / .625 1	1	4 1/8	29 3/4	29 3/4	RB-191	RB-191	2	2
	1A	1	4 1/8	29 3/4	29 3/4	RB-191	RB-191	2	2
	2A	.625	4 1/8	30 13/16	30 13/16	-	-	9	9

KA22-809

GM

Muelle Trasera

- Aplicación: C-30 Estacas Doble Rodada
- Modelo: 73-91
- Capacidad: 3470 lb

#Original: 6271320
#Rassini: 23C-341

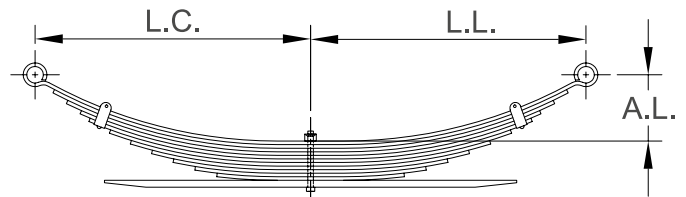

ANCHO	# HOJAS	CALIBRE	ARCO LIBRE	LONGITUD LADO CORTO	LONGITUD LADO LARGO	BUJE LADO CORTO	BUJE LADO LARGO	PUNTA LADO CORTO	PUNTA LADO LARGO
2 1/2	12 / .323	-	6	26	30	RB-117	RB-117	2	2
	1A	.323	6	26	30	RB-117	RB-117	2	2
	2A	.323	6	24 1/8	28 1/8	-	-	10	10
	2R	.323	6	26	30	-	-	7A	7A
	3A	.323	6	22 3/4	26 3/8	-	-	10	10
	4A	.323	6	21 3/8	24 1/2	-	-	10	10
	5A	.323	6	20 1/2	22 3/4	-	-	10	10
	6A	.323	6	18 1/2	21 1/8	-	-	17	17
	7A	.323	6	16 1/2	19 1/8	-	-	10	10

KA22-807

GM





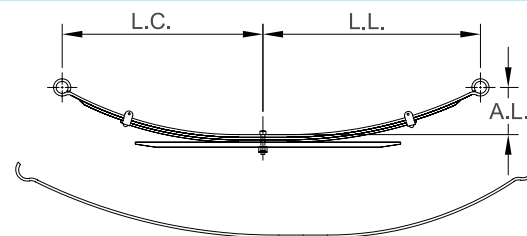

Muelle Trasera

- Aplicación: Blazer
- Modelo: 95
- Capacidad: 1400 lb

#Original: 15568339

#Rassini: 23C360G



ANCHO	# HOJAS	CALIBRE	ARCO LIBRE	LONGITUD LADO CORTO	LONGITUD LADO LARGO	BUJE LADO CORTO	BUJE LADO LARGO	PUNTA LADO CORTO	PUNTA LADO LARGO
2 1/2	4 / .323	.323	7 3/4	26	28	RB-117	RB-117	 2	2 
	1A	.323	7 3/4	26	28	RB-117	RB-117	 2	2 
	2R	.323	7 3/4	26	28	-	-	 7A	7A 

KA22-801

GM



Muelle Trasera

- Aplicación: Single Leaf Helper Spring
- Capacidad: 575 lb

#Original:

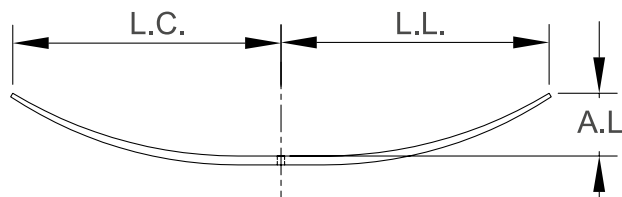
15659390



ANCHO	# HOJAS	CALIBRE	ARCO LIBRE	LONGITUD LADO CORTO	LONGITUD LADO LARGO	BUJE LADO CORTO	BUJE LADO LARGO	PUNTA LADO CORTO	PUNTA LADO LARGO
2 1/2	1 / .750	-	4 3/8	24 5/8	24 5/8	-	-	 16	16 

KA22-797-P









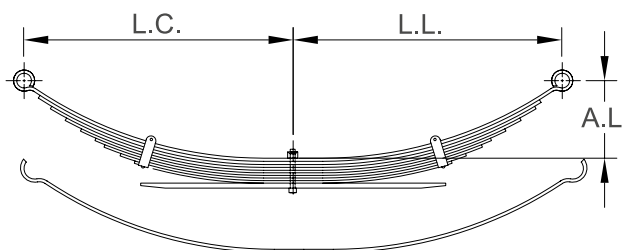







GM

Muelle Trasera

- Aplicación: Doble Rodada
- Modelo: 94
- Capacidad: 2235 lb

#Rassini: 23C-400



ANCHO	# HOJAS	CALIBRE	ARCO LIBRE	LONGITUD LADO CORTO	LONGITUD LADO LARGO	BUJE LADO CORTO	BUJE LADO LARGO	PUNTA LADO CORTO	PUNTA LADO LARGO
2 1/2	10 / .360, .625	-	6 5/8	32	32	RB-117	RB-117	 2	2 
	1A	.360	6 5/8	32	32	RB-117	RB-117	 2	2 
	2A	.360	6 5/8	30	30	-	-	 10	10 
	2AR	.360	6 5/8	32	32	-	-	 7A	7A 
	3A	.360	6 5/8	27 9/16	27 9/16	-	-	 10	10 
	4A	.360	6 5/8	25 1/8	25 1/8	-	-	 10	10 
	5A	.360	6 5/8	22 3/4	22 3/4	-	-	 13	13 
	6A	.625	6 5/8	20 1/4	20 1/4	-	-	 15	15 

KA22-797A-P

GM

Muelle Trasera

- Aplicación: P-30 Estacas Doble Rodada
- Modelo: 2007

#Original: 15636134
#Rassini: 22-873

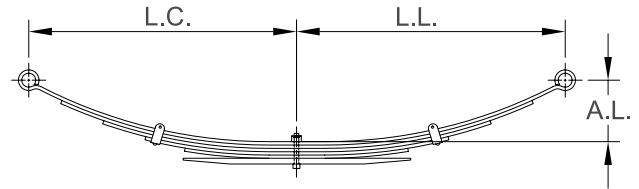

ANCHO	# HOJAS	CALIBRE	ARCO LIBRE	LONGITUD LADO CORTO	LONGITUD LADO LARGO	BUJE LADO CORTO	BUJE LADO LARGO	PUNTA LADO CORTO	PUNTA LADO LARGO
3	7 / .499	-	6 5/8	28	28	1 13/16	1 13/16	2	2
	1A	.499	6 5/8	28	28	1 13/16	1 13/16	2	2
	2A	.499	6 5/8	24 1/2	24 1/2	-	-	10	10
	2R	.499	6 5/8	28	28	-	-	7A	7A
	3A	.499	6 5/8	18 1/2	18 1/2	-	-	13	13
	4A	.499	6 5/8	13	13	-	-	10	10
	5A	.499	6 5/8	8 1/4	8 1/4	-	-	10	10

KA22-795

GM

Muelle Trasera

- Aplicación: Chevy Pickup 32 X 32 Sprin
- Modelo: 88-98
- Capacidad: 2025 lb

#Original: 15620357
#Rassini: 23C-400

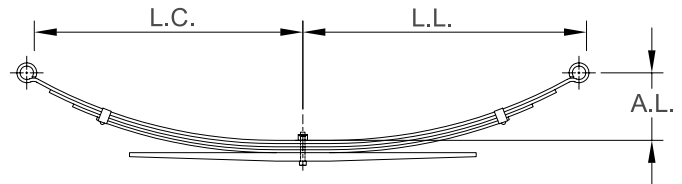

ANCHO	# HOJAS	CALIBRE	ARCO LIBRE	LONGITUD LADO CORTO	LONGITUD LADO LARGO	BUJE LADO CORTO	BUJE LADO LARGO	PUNTA LADO CORTO	PUNTA LADO LARGO
2 1/2	5 / .360,999	-	7 9/16	32	32	RB172-B	RB172-B	2	2

KA22-793

GM

Muelle Trasera

- Aplicación: C-20 Rodado Sencillo
- Modelo: 92-93
- Capacidad: 1425 lb

#Original: 73422799
#Rassini: 23C-400

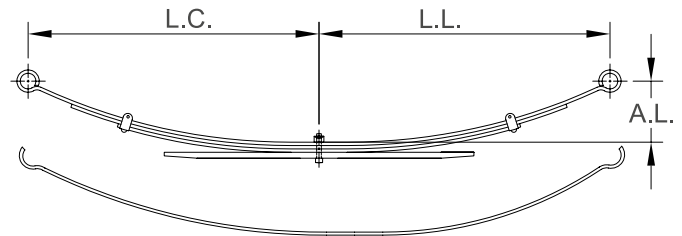

ANCHO	# HOJAS	CALIBRE	ARCO LIBRE	LONGITUD LADO CORTO	LONGITUD LADO LARGO	BUJE LADO CORTO	BUJE LADO LARGO	PUNTA LADO CORTO	PUNTA LADO LARGO
2 1/2	6 / .360,625	-	5 1/2	32	32	RB-117	RB-117	2	2
	1A	.360	5 1/2	32	32	RB-117	RB-117	2	2
	2A	.360	5 1/2	28 3/4	28 3/4	-	-	10	10
	2R	.360	5 1/2	34 1/4	34 1/4	-	-	7A	7A
	3A	.360	5 1/2	25 1/4	25 1/4	-	-	13	13
	4A	.625	5 1/2	21 5/8	21 5/8	-	-	15	15

KA22-687

GM

Muelle Trasera

- Aplicación: S10 4 Leaf Spring 1350
- Modelo: 83-94
- Capacidad: 1350 lb

#Original: 14060056
#Rassini: 23C-360-G

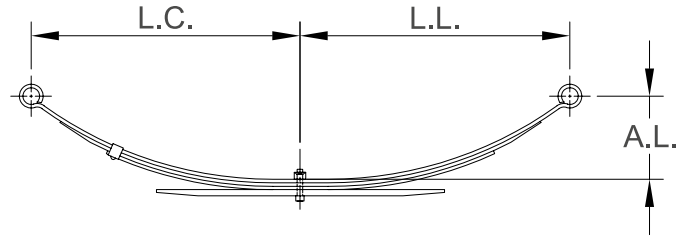

ANCHO	# HOJAS	CALIBRE	ARCO LIBRE	LONGITUD LADO CORTO	LONGITUD LADO LARGO	BUJE LADO CORTO	BUJE LADO LARGO	PUNTA LADO CORTO	PUNTA LADO LARGO
2 1/2	4 / .291,.625	-	7 1/2	26	28	RB117-B	RB117-B	2	2

KA22-547

GM

Muelle Trasera

- Aplicación: Pick Up Spring
- Modelo: 73-87
- Capacidad: 2600 lb

#Original: 357246
#Rassini: 23C-360-C

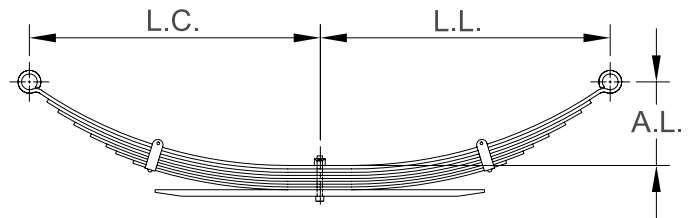

ANCHO	# HOJAS	CALIBRE	ARCO LIBRE	LONGITUD LADO CORTO	LONGITUD LADO LARGO	BUJE LADO CORTO	BUJE LADO LARGO	PUNTA LADO CORTO	PUNTA LADO LARGO
2 1/2	9 / .323,.307,.291,.770	-	6 1/4	26	30	RB136-B	RB117-B	2	2

KA22-531

GM

Muelle Trasera

- Aplicación: Single Leaf Helper - 56" SPG
- Capacidad: 1050 lb

#Original: 350726
#Rassini: 23C-440

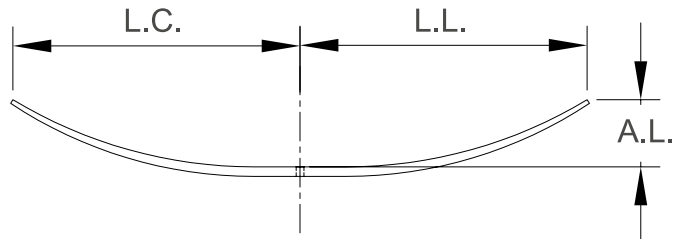

ANCHO	# HOJAS	CALIBRE	ARCO LIBRE	LONGITUD LADO CORTO	LONGITUD LADO LARGO	BUJE LADO CORTO	BUJE LADO LARGO	PUNTA LADO CORTO	PUNTA LADO LARGO
2 1/2	1 / .625	-	3 7/8	20 3/4	22 3/8	-	-	16	16

KA22-492

GM

Muelle Delantera

- Aplicación: Camioneta 5t C3500 HD Parabólica
- Modelo: 1997
- Capacidad: 1615 lb

#Original: 15638995

#Rassini: 22-492

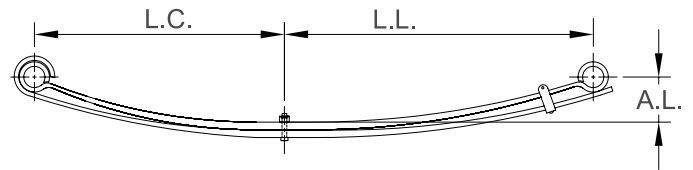

ANCHO	# HOJAS	CALIBRE	ARCO LIBRE	LONGITUD LADO CORTO	LONGITUD LADO LARGO	BUJE LADO CORTO	BUJE LADO LARGO	PUNTA LADO CORTO	PUNTA LADO LARGO
2 1/2	2 / .625	-	4 1/2	28 1/2	28 1/2	RB-117	RB-117	2	2
	1A	.625	4 1/2	28 1/2	28 1/2	RB-117	RB-117	2	2
	2A	.625	4 1/2	28 1/2	28 1/2	-	-	7	8
	3R	.625	4 1/2	25	25	-	-	15	15

KA22-490

GM

Muelle Delantera

- Aplicación: Camión Kodiak
- Modelo: 1997
- Capacidad: 6485 lb

#Original: 93427625

#Rassini: 22-490

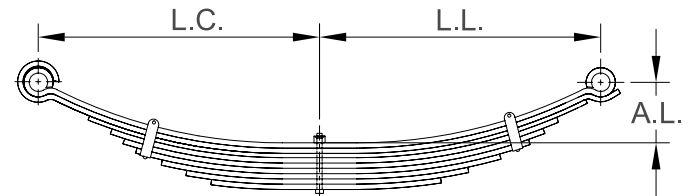

ANCHO	# HOJAS	CALIBRE	ARCO LIBRE	LONGITUD LADO CORTO	LONGITUD LADO LARGO	BUJE LADO CORTO	BUJE LADO LARGO	PUNTA LADO CORTO	PUNTA LADO LARGO
4	9 / .499	-	6 3/4	25 1/8	35	1 13/16	1 13/16	2	2
	1A	.499	6 3/4	25 1/8	35	1 13/16	1 13/16	2	2
	2A	.499	6 3/4	25 1/8	35	-	-	7	8
	3A	.499	6 3/4	21	31	-	-	10	10

KA22-484

GM

Muelle Delantera

- Aplicación: Muelle Delantera Kodiak Serie C
- Modelo: 1997
- Capacidad: 5380 lb

#Original: 15574818

#Rassini: 22-490

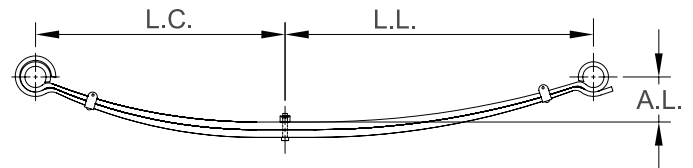

ANCHO	# HOJAS	CALIBRE	ARCO LIBRE	LONGITUD LADO CORTO	LONGITUD LADO LARGO	BUJE LADO CORTO	BUJE LADO LARGO	PUNTA LADO CORTO	PUNTA LADO LARGO
4	2 / .788	.788	5	25 1/8	35	RB-190	RB-190	2	2
	1A	.788	5	25 1/8	35	RB-190	RB-190	2	2
	2A	.788	5	25 1/8	35	-	-	7	9

KA22-482

GM

Muelle Delantera

- Aplicación: Topkick 2 Leaf Taper 9.0K AX
- Capacidad: 4050 lb

#Original: 15651014

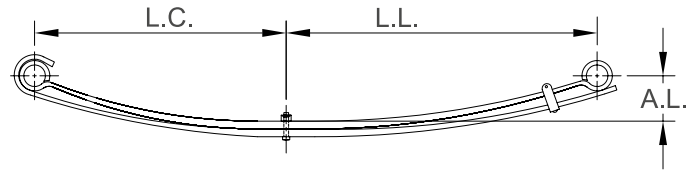

ANCHO	# HOJAS	CALIBRE	ARCO LIBRE	LONGITUD LADO CORTO	LONGITUD LADO LARGO	BUJE LADO CORTO	BUJE LADO LARGO	PUNTA LADO CORTO	PUNTA LADO LARGO
3 1/2	2 / .788	.788	5 1/16	25 1/8	35	RB190-B	RB190-B	2	2

KA22-480

GM

Muelle Delantera

- Aplicación: Camión Kodiak
- Modelo: 1997
- Capacidad: 3615 lb

#Original: 93427625
#Rassini: 22-420 A

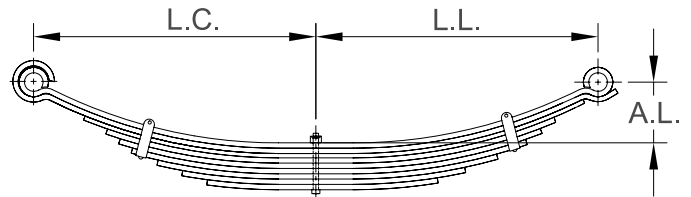

ANCHO	# HOJAS	CALIBRE	ARCO LIBRE	LONGITUD LADO CORTO	LONGITUD LADO LARGO	BUJE LADO CORTO	BUJE LADO LARGO	PUNTA LADO CORTO	PUNTA LADO LARGO
3 1/2	9 / .499	.499	5 11/16	25 1/8	35	RB-190	RB-190	2	2
	1A	.499	5 11/16	25 1/8	35	RB-190	RB-190	2	2
	2A	.499	5 11/16	25 1/8	35	-	-	7	8
	3A	.499	5 11/16	21	31	-	-	10	10

KA22-440

GM

Muelle Trasera

- Aplicación: Microbus Delantero
- Modelo: 2000
- Capacidad: 2200 lb

#Original: 15599391

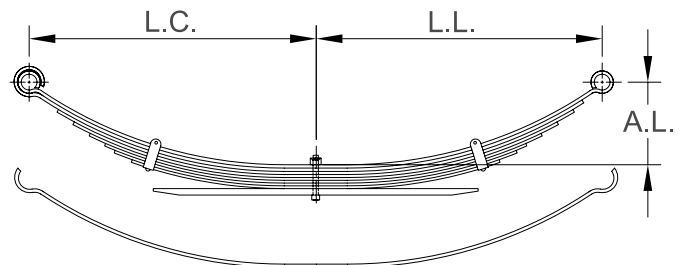

ANCHO	# HOJAS	CALIBRE	ARCO LIBRE	LONGITUD LADO CORTO	LONGITUD LADO LARGO	BUJE LADO CORTO	BUJE LADO LARGO	PUNTA LADO CORTO	PUNTA LADO LARGO
2 1/2	7 / .360	.36	6 1/2	29	29	RB-117	RB-117	2	2
	1A	.36	6 1/2	29	29	RB-117	RB-117	2	2
	2A	.36	6 1/2	29	29	-	-	4	10

KA22-417-P

GM

Muelle Auxiliar

- Aplicación: C-30 Doble Rodada
- Modelo: 75-89

#Original: 671324
#Rassini: 23C280

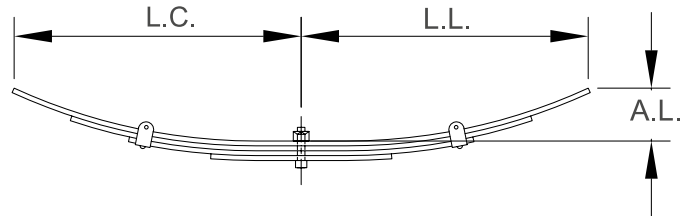

ANCHO	# HOJAS	CALIBRE	ARCO LIBRE	LONGITUD LADO CORTO	LONGITUD LADO LARGO	BUJE LADO CORTO	BUJE LADO LARGO	PUNTA LADO CORTO	PUNTA LADO LARGO
2 1/2	4 / .323	-	3 1/2	19 1/2	19 1/2	-	-	21	21
	1A	.323	3 1/2	19 1/2	19 1/2	-	-	21	21
	2A	.323	3 1/2	15 1/2	15 1/2	-	-	21	21
	3A	.323	3 1/2	11 1/4	11 1/4	-	-	13	13
	4A	.323	3 1/2	7	7	-	-	21	21

KA22-417C

GM

Muelle Auxiliar

- Aplicación: C-30 Doble Rodada
- Modelo: 94

#Original: 15697901
#Rassini: 23C-420

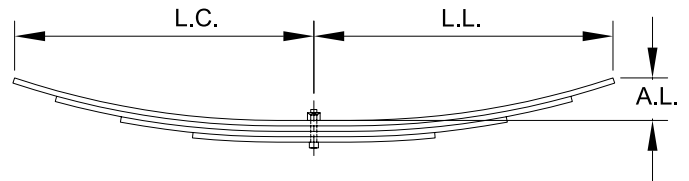

ANCHO	# HOJAS	CALIBRE	ARCO LIBRE	LONGITUD LADO CORTO	LONGITUD LADO LARGO	BUJE LADO CORTO	BUJE LADO LARGO	PUNTA LADO CORTO	PUNTA LADO LARGO
2 1/2	4 / .447	.477	4 3/4	25	25	-	-	21	21
	1A	.447	4 3/4	25	25	-	-	21	21
	2A	.447	4 3/4	16	16	-	-	21	21
	2R	.447	4 3/4	21 1/2	21 1/2	-	-	21	21
	3A	.447	4 3/4	10	10	-	-	13	13

KA22-417B

GM

Muelle Auxiliar

- Aplicación: Auxiliar C-30 Rodada Doble
- Modelo: 73-89

#Original: 15151112
#Rassini: 23C-280

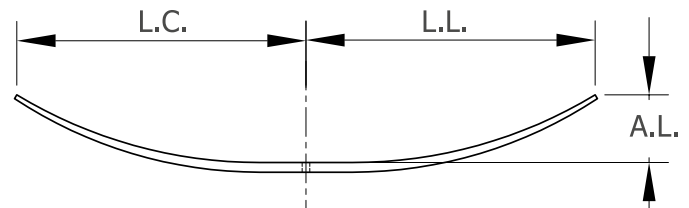

ANCHO	# HOJAS	CALIBRE	ARCO LIBRE	LONGITUD LADO CORTO	LONGITUD LADO LARGO	BUJE LADO CORTO	BUJE LADO LARGO	PUNTA LADO CORTO	PUNTA LADO LARGO
2 1/2	1 / .625	.625	2 1/4	20 1/2	20 1/2	-	-	15	15
	1A	.625	2 1/4	20 1/2	20 1/2	-	-	15	15









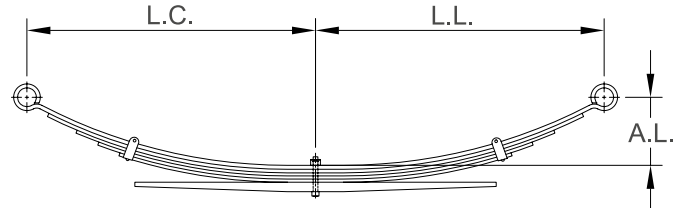









KA22-403-P

GM

Muelle Trasera

- Aplicación: P-30 Estacas Doble Rodada
- Modelo: 72-89 #Rassini: 23C-261



ANCHO	# HOJAS	CALIBRE	ARCO LIBRE	LONGITUD LADO CORTO	LONGITUD LADO LARGO	BUJE LADO CORTO	BUJE LADO LARGO	PUNTA LADO CORTO	PUNTA LADO LARGO
2 1/2	8 / .323, .625	-	6 1/2	26	26	RB117	RB117	 2	2 
	1A	.323	6 1/2	26	26	RB117	RB117	 2	2 
	2A	.323	6 1/2	24	24	-	-	 10	10 
	2R	.323	6 1/2	26	26	-	-	 7A	7A 
	3A	.323	6 1/2	22 1/4	22 1/4	-	-	 10	10 
	4A	.323	6 1/2	20 1/4	20 1/4	-	-	 10	10 
	5A	.323	6 1/2	19	19	-	-	 10	10 
	6A	.323	6 1/2	16 1/2	16 1/2	-	-	 13	13 
	7A	.625	6 1/2	14	14	-	-	 15	15 

KA22-403D

GM

Muelle Trasera

- Aplicación: Chevrolet Lub #Original: 8970619380
- Modelo: 2000
- Capacidad: 2100 lb

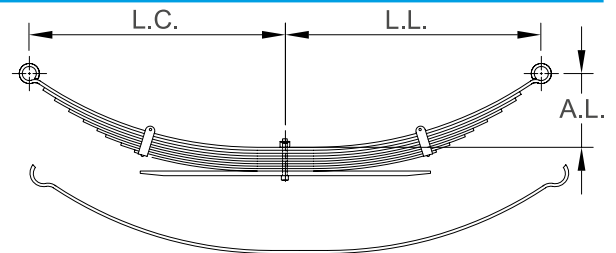

ANCHO	# HOJAS	CALIBRE	ARCO LIBRE	LONGITUD LADO CORTO	LONGITUD LADO LARGO	BUJE LADO CORTO	BUJE LADO LARGO	PUNTA LADO CORTO	PUNTA LADO LARGO
2 1/4	4 / .323	-	6	21 1/2	25 1/4	-	-	 2	2 
	1A	.323	6	21 1/2	25 1/4	-	-	 2	2 
	2R	.323	6	21 1/2	25 1/4	-	-	 7A	7A 





KA22-402

GM

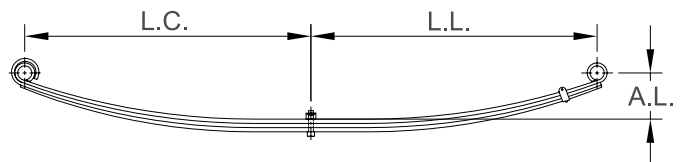
Muelle Delantera

- Aplicación: 3 Leaf 4X4 Taper Spring
- Modelo: 70-87
- Capacidad: 1900 lb



ANCHO	# HOJAS	CALIBRE	ARCO LIBRE	LONGITUD LADO CORTO	LONGITUD LADO LARGO	BUJE LADO CORTO	BUJE LADO LARGO	PUNTA LADO CORTO	PUNTA LADO LARGO
3	3 / .360	-	2	23 1/2	23 1/2	RB98	-	 1	1 
2 3/4	3A	.447	2 1/2	23 1/4	23 1/4	-	-	 9	9 

KA22-338

GM

Muelle Delantera

- Aplicación: Series 50-60 550 lb Roleo Berlín
- Modelo: 67-77
- Capacidad: 4500 lb

#Original: 389-1345

#Rassini: 22-360

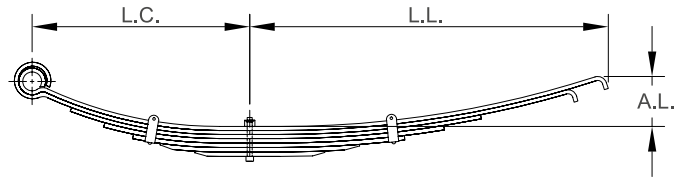

ANCHO	# HOJAS	CALIBRE	ARCO LIBRE	LONGITUD LADO CORTO	LONGITUD LADO LARGO	BUJE LADO CORTO	BUJE LADO LARGO	PUNTA LADO CORTO	PUNTA LADO LARGO
3	7 / .401	-	5	22 1/2	35 5/8	RB-73	PATIN	2	18
	1A	.401	5	22 1/2	35 5/8	RB-73	PATIN	2	18
	2A	.401	5	22 1/2	32	-	-	7	18
	3A	.401	5	18 1/4	23 1/4	-	-	10	10

KA22-336

GM

Muelle Delantera

- Aplicación: Series 50-60 550 lb Roleo Berlín Ovalado
- Modelo: 67-77
- Capacidad: 3500 lb

#Original: 389-1344

#Rassini: 22-340

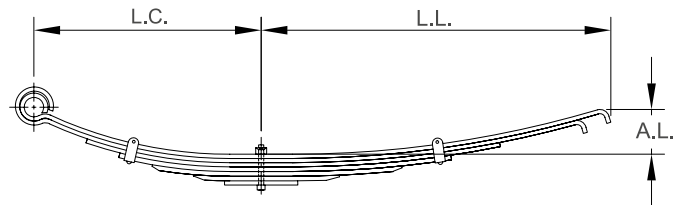

ANCHO	# HOJAS	CALIBRE	ARCO LIBRE	LONGITUD LADO CORTO	LONGITUD LADO LARGO	BUJE LADO CORTO	BUJE LADO LARGO	PUNTA LADO CORTO	PUNTA LADO LARGO
3	7 / .401	-	4 1/2	22 7/16	33 7/16	RB-94	PATIN	2	18
	1A	.401	4 1/2	22 7/16	33 4/9	RB-94	PATIN	2	18
	2A	.401	4 1/2	22 7/16	30 7/8	-	-	7	18
	3R	.401	4 1/2	20	28 1/2	-	-	10	10
	4A	.447	4 1/2	13 3/4	18 1/4	-	-	13	13

KA22-315

GM

Muelle Trasera

- Aplicación: 6 Leaf Helper 2000

#Original: 3763787

#Rassini: 23-320

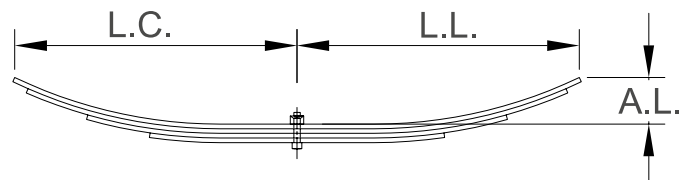

ANCHO	# HOJAS	CALIBRE	ARCO LIBRE	LONGITUD LADO CORTO	LONGITUD LADO LARGO	BUJE LADO CORTO	BUJE LADO LARGO	PUNTA LADO CORTO	PUNTA LADO LARGO
3	4 / .360	-	3 5/8	19 1/2	19 1/2	-	-	21	21



KA50-403

HENDRICKSON

Muelle Zeta

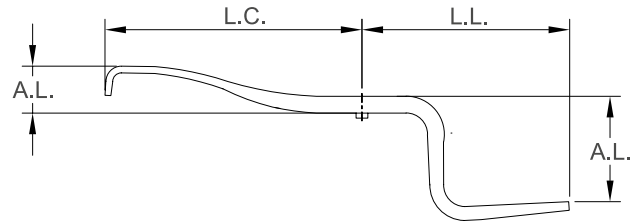
- Aplicación: Z Spring For Line Haul 20.0 #Original: 57217000



ANCHO	# HOJAS	CALIBRE	ARCO LIBRE	LONGITUD LADO CORTO	LONGITUD LADO LARGO	BUJE LADO CORTO	BUJE LADO LARGO	PUNTA LADO CORTO	PUNTA LADO LARGO
3	1 / 1.750	1.75	ESPECIAL	24	23 3/8	-	-	 11	17 

KA50-389

HENDRICKSON

Muelle Zeta

- Aplicación: Repuesto Z Hendrickson

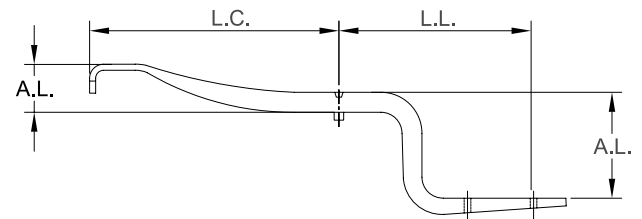

ANCHO	# HOJAS	CALIBRE	ARCO LIBRE	LONGITUD LADO CORTO	LONGITUD LADO LARGO	BUJE LADO CORTO	BUJE LADO LARGO	PUNTA LADO CORTO	PUNTA LADO LARGO
3	1 / 2"	2	ESPECIAL	23 1/2	20 1/16	-	-	 18	16 



KA50-387

HENDRICKSON

Muelle Zeta

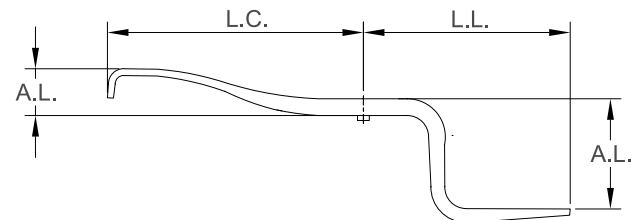
- Aplicación: Suspensión Hendrickson #Original: 56943-000
- Capacidad: 9450 lb



ANCHO	# HOJAS	CALIBRE	ARCO LIBRE	LONGITUD LADO CORTO	LONGITUD LADO LARGO	BUJE LADO CORTO	BUJE LADO LARGO	PUNTA LADO CORTO	PUNTA LADO LARGO
3	1 / 1.890	1.89	ESPECIAL	24	20	-	-	 18	16 



KA50-367

HENDRICKSON

Muelle Zeta

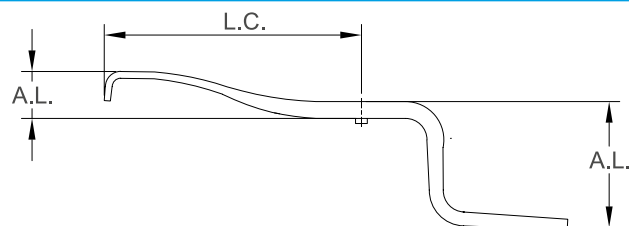
- Aplicación: Z Spring 20,000 Axle Ratin #Original: 56871001
- Capacidad: 9000 lb



ANCHO	# HOJAS	CALIBRE	ARCO LIBRE	LONGITUD LADO CORTO	LONGITUD LADO LARGO	BUJE LADO CORTO	BUJE LADO LARGO	PUNTA LADO CORTO	PUNTA LADO LARGO
3	1 / 1.890	1.89	ESPECIAL	24	20 3/4	-	-	 11	17 

KA50-317-P

HENDRICKSON

Muelle Delantera

- Aplicación: Suspensión Hendrickson E4 #Original: 47-475 #Rassini: 80-280-B
- Modelo: 94
- Capacidad: 8500 lb

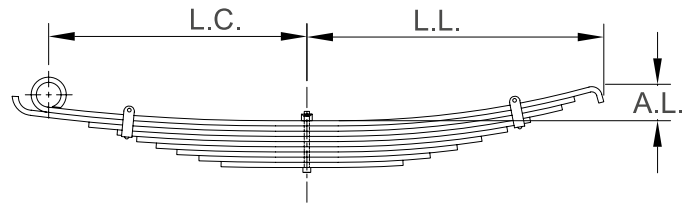

ANCHO	# HOJAS	CALIBRE	ARCO LIBRE	LONGITUD LADO CORTO	LONGITUD LADO LARGO	BUJE LADO CORTO	BUJE LADO LARGO	PUNTA LADO CORTO	PUNTA LADO LARGO
3	9 / .499	.499	3 1/2	18 15/16	24 13/16	RB167	-	1	18
	1A	.499	3 1/2	18 15/16	24 13/16	RB167	-	1	18
	2A	.499	3 1/2	23 3/4	22 1/2	-	-	11	21
	3A	.499	3 1/2	17	17 3/4	-	-	10	10
	3R	.499	3 1/2	18	20	-	-	10	10
	4A	.499	3 1/2	15 1/2	14 1/4	-	-	10	10
	5A	.499	3 1/2	12 1/2	13 1/4	-	-	13	13
	7A	.499	3 1/2	8 1/2	8 1/2	-	-	10	10

KA50-301

HENDRICKSON

Muelle Trasera

- Aplicación: Hendrickson RT440, #Original: BA47057 BA47057 #Rassini: 50-301
- Modelo: 68-69

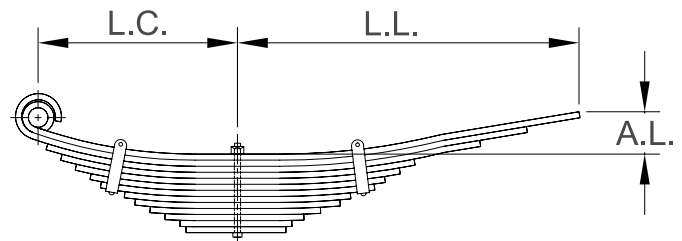

ANCHO	# HOJAS	CALIBRE	ARCO LIBRE	LONGITUD LADO CORTO	LONGITUD LADO LARGO	BUJE LADO CORTO	BUJE LADO LARGO	PUNTA LADO CORTO	PUNTA LADO LARGO
4	13 / .558	.558	2 3/4	17 1/16	20 3/8	TPK	-	1	21
	1A	.558	2 3/4	17 1/16	20 3/8	TPK	-	1	21
	2A	.558	2 3/4	17 1/16	18 3/4	-	-	4	21
	3A	.558	2 3/4	17 1/16	17 1/16	-	-	10	10
	4A	.558	2 3/4	15 1/2	15 1/2	-	-	10	10
	5A	.558	2 3/4	14 1/8	14 1/8	-	-	21	21
	6A	.558	2 3/4	12 3/4	12 3/4	-	-	21	21
	7A	.558	2 3/4	11 3/4	11 3/4	-	-	13	13
	8A	.558	2 3/4	9 3/4	9 3/4	-	-	21	21
	9A	.558	2 3/4	8 3/4	8 3/4	-	-	21	21
	10A	.558	2 3/4	7 1/2	7 1/2	-	-	21	21
	11A	.558	2 3/4	6 1/8	6 1/8	-	-	21	21
	12A	.558	2 3/4	4 15/16	4 15/16	-	-	21	21
	13A	.558	2 3/4	3 1/2	3 1/2	-	-	21	21

KA50-291
HENDRICKSON
Muelle Trasera

- Aplicación: Hendrickson Ba45027
- Modelo: 68-69
- Capacidad: 15500 lb

#Original: 471347C91
#Rassini: 71-121-A

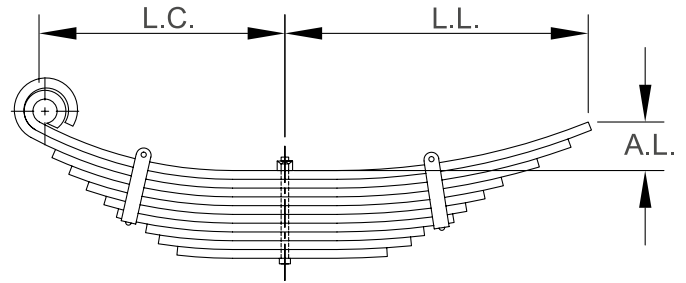

ANCHO	# HOJAS	CALIBRE	ARCO LIBRE	LONGITUD LADO CORTO	LONGITUD LADO LARGO	BUJE LADO CORTO	BUJE LADO LARGO	PUNTA LADO CORTO	PUNTA LADO LARGO
4	10 / .558	-	3 1/4	17	20 3/4	TPK	-	 1	21 

KA50-275
HENDRICKSON
Muelle Trasera

- Aplicación: Hendrickson Rte380, Ba45121, Torton 631
- Modelo: 80-82

#Original: BA45121
#Rassini: 71125-C

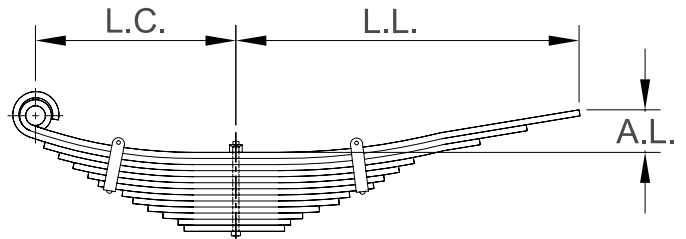

ANCHO	# HOJAS	CALIBRE	ARCO LIBRE	LONGITUD LADO CORTO	LONGITUD LADO LARGO	BUJE LADO CORTO	BUJE LADO LARGO	PUNTA LADO CORTO	PUNTA LADO LARGO
4	13 / .558, .499, .447	-	2 1/4	17 1/8	28 1/2	TPK	-	 1	21 

KA50-267
HENDRICKSON
Muelle Trasera

- Aplicación: Hendrickson

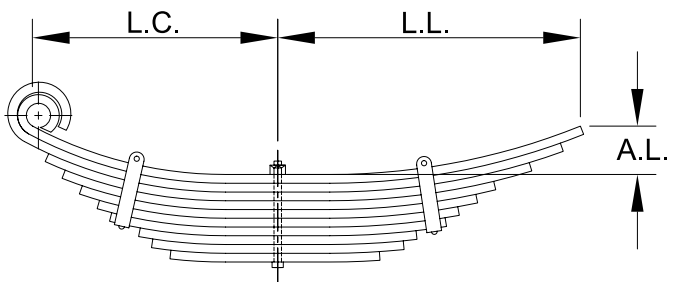

ANCHO	# HOJAS	CALIBRE	ARCO LIBRE	LONGITUD LADO CORTO	LONGITUD LADO LARGO	BUJE LADO CORTO	BUJE LADO LARGO	PUNTA LADO CORTO	PUNTA LADO LARGO
4	10 / .558	.558	3 1/4	17 1/16	20 11/16	TPK	-	 1	21 

KATRA-2757

HUTCHENS

Muelle Trasera

- Aplicación: Hutch 2 Stage #Original: 35500 Spring 16710

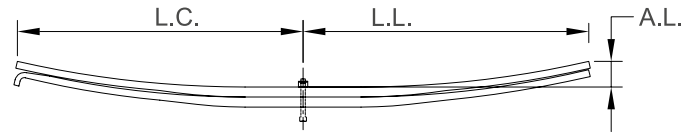

ANCHO	# HOJAS	CALIBRE	ARCO LIBRE	LONGITUD LADO CORTO	LONGITUD LADO LARGO	BUJE LADO CORTO	BUJE LADO LARGO	PUNTA LADO CORTO	PUNTA LADO LARGO
3	2 / 1.125	1.125	4 5/8	21 1/2	23	-	-	16	16

KATRA-2754

HUTCHENS

Muelle Trasera

- Aplicación: Hutch 326-00 2-Leaf Lo Arch
- Capacidad: 8500 lb

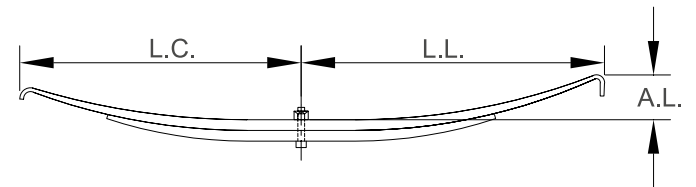

ANCHO	# HOJAS	CALIBRE	ARCO LIBRE	LONGITUD LADO CORTO	LONGITUD LADO LARGO	BUJE LADO CORTO	BUJE LADO LARGO	PUNTA LADO CORTO	PUNTA LADO LARGO
3	2 / .999	.999	4	22 15/16	21 5/8	-	-	11	11

KATRA-2752

HUTCHENS

Muelle Trasera

- Aplicación: Hutch 324-00 2-Leaf High AR
- Capacidad: 8500 lb

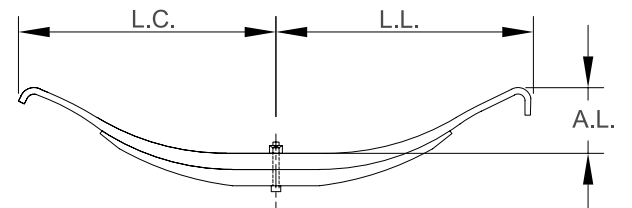

ANCHO	# HOJAS	CALIBRE	ARCO LIBRE	LONGITUD LADO CORTO	LONGITUD LADO LARGO	BUJE LADO CORTO	BUJE LADO LARGO	PUNTA LADO CORTO	PUNTA LADO LARGO
3	2 / .999	.999	6 1/4	23 9/16	22 7/16	-	-	11	11

KATRA-2750

HUTCHENS

Muelle Trasera

- Aplicación: Hutch 3-Leaf Single Point
- Capacidad: 23500 lb

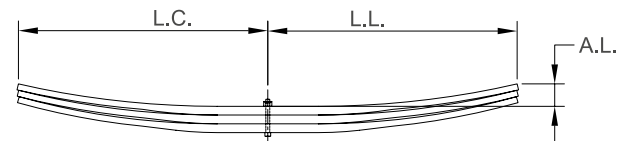

ANCHO	# HOJAS	CALIBRE	ARCO LIBRE	LONGITUD LADO CORTO	LONGITUD LADO LARGO	BUJE LADO CORTO	BUJE LADO LARGO	PUNTA LADO CORTO	PUNTA LADO LARGO
5	3 / 1.125	1.125	2 11/16	32 1/4	32 1/4	-	-	17	17
	1A	-	2 11/16	32 1/4	32 1/4	-	-	17	17

KATRA-2728

HUTCHENS

Muelle Trasera

- Aplicación: Caja Americana
- Modelo: 98
- Capacidad: 8500 lb

#Original: 35600
#Rassini: TRA-2728

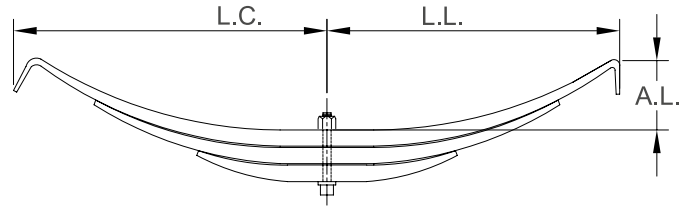

ANCHO	# HOJAS	CALIBRE	ARCO LIBRE	LONGITUD LADO CORTO	LONGITUD LADO LARGO	BUJE LADO CORTO	BUJE LADO LARGO	PUNTA LADO CORTO	PUNTA LADO LARGO
3	3 / .788	.788	3 1/4	21 1/4	22 7/16	-	-	11	11
	1A	.788	3 1/4	21 1/4	22 7/16	-	-	15	15
	2A	.788	3 1/4	14 1/2	14 1/2	-	-	15	15
	2A	.788	3 1/4	9 1/4	9 1/4	-	-	15	15

KATRA-2727

HUTCHENS

Muelle Trasera

- Aplicación: Caja Americana
- Modelo: 98
- Capacidad: 8500 lb

#Original: HH355
#Rassini: TRA-2727

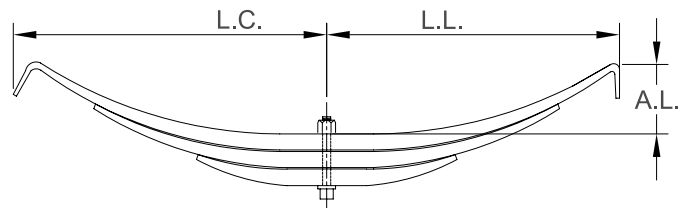

ANCHO	# HOJAS	CALIBRE	ARCO LIBRE	LONGITUD LADO CORTO	LONGITUD LADO LARGO	BUJE LADO CORTO	BUJE LADO LARGO	PUNTA LADO CORTO	PUNTA LADO LARGO
3	3 / .788	.788	4 1/2	21 3/4	22 9/16	-	-	11	11
	1A	.788	4 1/2	21 3/4	22 9/16	-	-	11	11
	2A	.788	4 1/2	14 1/2	14 1/2	-	-	15	15
	2R	.788	4 1/2	20 1/2	20 1/2	-	-	15	15
	3A	.788	4 1/2	9 1/4	9 1/4	-	-	15	15

KATRA-2726

HUTCHENS

Muelle Trasera

- Aplicación: Caja Americana
- Modelo: 98
- Capacidad: 8500 lb

#Original: H354
#Rassini: TRA-2726

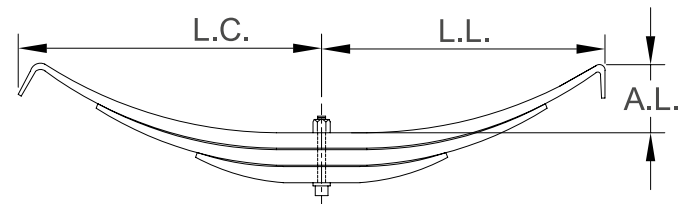

ANCHO	# HOJAS	CALIBRE	ARCO LIBRE	LONGITUD LADO CORTO	LONGITUD LADO LARGO	BUJE LADO CORTO	BUJE LADO LARGO	PUNTA LADO CORTO	PUNTA LADO LARGO
3	3 / .788	-	6	22 1/2	23 5/8	-	-	11	11
	1A	-	6	22 1/2	23 5/8	-	-	11	11
	2A	-	6	14 1/2	14 1/2	-	-	15	15
	3A	-	6	9 1/4	9 1/4	-	-	15	15

KATRA-2727HD

HUTCHENS

- Aplicación: Caja Americana

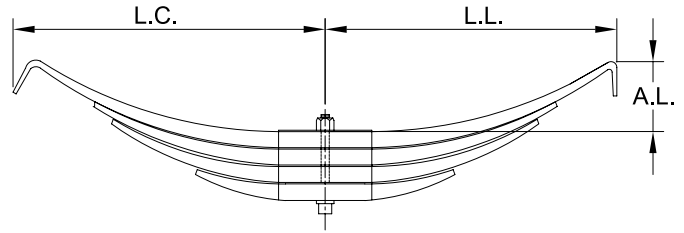

ANCHO	# HOJAS	CALIBRE	ARCO LIBRE	LONGITUD LADO CORTO	LONGITUD LADO LARGO	BUJE LADO CORTO	BUJE LADO LARGO	PUNTA LADO CORTO	PUNTA LADO LARGO
3	4/.788	.788	7 19/32	22 9/16	21 1/4	-	-	11	11

KATRA-2741

HUTCHENS

Muelle Trasera

- Aplicación: Hutch 3 Leaf Low Arch 365-0
- Capacidad: 11000 lb
- #Original: 365-01
- #Rassini: TRA-2741

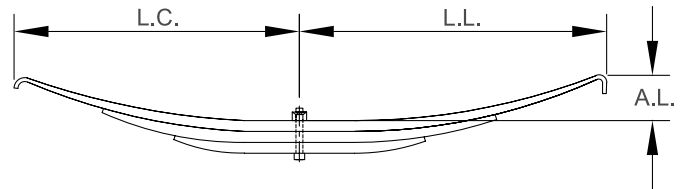

ANCHO	# HOJAS	CALIBRE	ARCO LIBRE	LONGITUD LADO CORTO	LONGITUD LADO LARGO	BUJE LADO CORTO	BUJE LADO LARGO	PUNTA LADO CORTO	PUNTA LADO LARGO
3	3 / 1"	1	ESPECIAL	21 1/2	22 3/4	-	-	11	11
	1A	1	ESPECIAL	21 1/2	22 3/4	-	-	11	11
	2A	1	ESPECIAL	15 1/4	15 1/4	-	-	15	15
	2R	1	ESPECIAL	20 1/2	20 1/2	-	-	15	15
	3A	1	ESPECIAL	9 3/8	9 3/8	-	-	15	15

KATRA-2740

HUTCHENS

Muelle Trasera

- Aplicación: Hutch 3 Leaf Hi-Arch 365-00
- Capacidad: 11000 lb
- #Original: 365-00
- #Rassini: TRA-2740

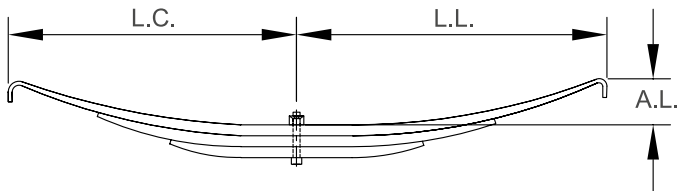

ANCHO	# HOJAS	CALIBRE	ARCO LIBRE	LONGITUD LADO CORTO	LONGITUD LADO LARGO	BUJE LADO CORTO	BUJE LADO LARGO	PUNTA LADO CORTO	PUNTA LADO LARGO
3	3 / 1"	1	ESPECIAL	22 1/2	21 1/4	-	-	11	11
	1A	1	ESPECIAL	22 1/2	21 1/4	-	-	11	11
	2A	1	ESPECIAL	15 1/4	15 1/4	-	-	15	15
	2R	1	ESPECIAL	20 1/2	20 1/2	-	-	15	15
	3A	1	ESPECIAL	9 3/8	9 3/8	-	-	15	15

KATRA-2726HD

HUTCHENS

- Aplicación: Caja Americana

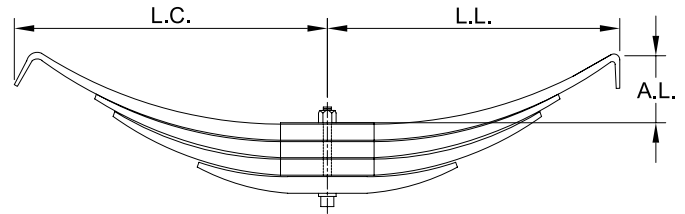

ANCHO	# HOJAS	CALIBRE	ARCO LIBRE	LONGITUD LADO CORTO	LONGITUD LADO LARGO	BUJE LADO CORTO	BUJE LADO LARGO	PUNTA LADO CORTO	PUNTA LADO LARGO
3	4/.788	.788	8 7/32	22 1/2	21 1/4	-	-	11	11

KATRA-2705

HUTCHENS

Muelle Trasera

- Aplicación: Hutch 7 Leaf Hi-Arch 751-05 #Original: H751/751-05
- Capacidad: 9500 lb

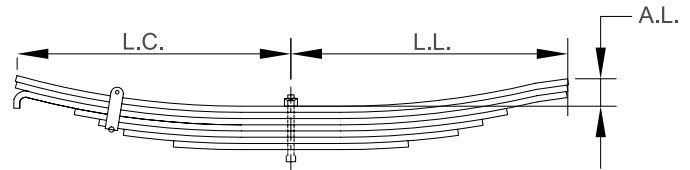

ANCHO	# HOJAS	CALIBRE	ARCO LIBRE	LONGITUD LADO CORTO	LONGITUD LADO LARGO	BUJE LADO CORTO	BUJE LADO LARGO	PUNTA LADO CORTO	PUNTA LADO LARGO
3	7/.499	.499	5 1/8	22 7/8	23 1/8	-	-	10	10

KATRA-2260

HUTCHENS

Muelle Trasera

- Aplicación: Hutchens #Original: H752A
- Capacidad: 11000 lb

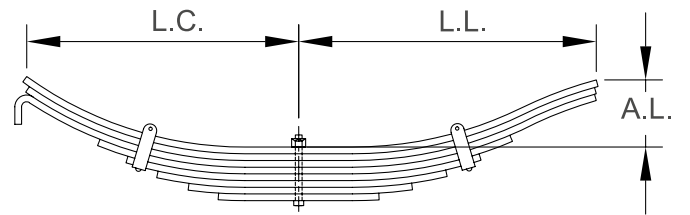

ANCHO	# HOJAS	CALIBRE	ARCO LIBRE	LONGITUD LADO CORTO	LONGITUD LADO LARGO	BUJE LADO CORTO	BUJE LADO LARGO	PUNTA LADO CORTO	PUNTA LADO LARGO
3	8/.499	.499	5 1/8	21 3/8	23 1/8	-	-	10	10
	1A	.499	5 1/8	21 3/8	23 1/8	-	-	10	10
	2A	.499	5 1/8	21 3/8	23 1/8	-	-	18	10
	3A	.499	5 1/8	15 1/4	16 1/4	-	-	10	10
	4A	.499	5 1/8	13	13 3/4	-	-	13	21
	5A	.499	5 1/8	10 5/8	11 1/8	-	-	21	21
	6A	.499	5 1/8	8 1/2	8 1/2	-	-	21	21
	7A	.499	5 1/8	6	6	-	-	21	21

KATRA-023

HUTCHENS

Muelle Trasera

- Aplicación: Hutchens Binkley #Original: H360
- Modelo: 2000 #Rassini: TRA-023
- Capacidad: 9500 lb

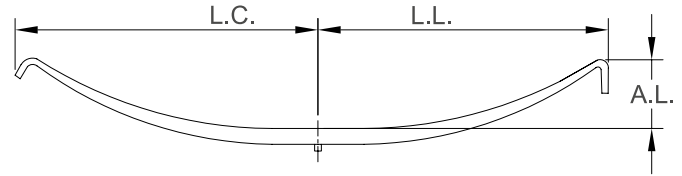

ANCHO	# HOJAS	CALIBRE	ARCO LIBRE	LONGITUD LADO CORTO	LONGITUD LADO LARGO	BUJE LADO CORTO	BUJE LADO LARGO	PUNTA LADO CORTO	PUNTA LADO LARGO
3	1 / 1.375	1.38	7 1/8	23 1/8	22 7/8	-	-	 11	11 



KATRA-021

HUTCHENS

Muelle Trasera

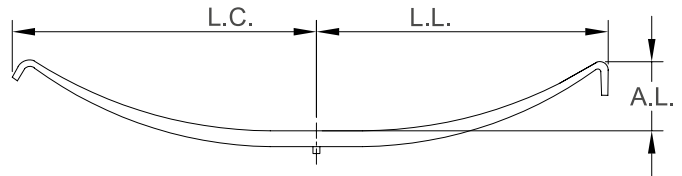
- Aplicación: Caja Americana #Original: H363
- Modelo: 2000 #Rassini: TRA021
- Capacidad: 9500 lb



ANCHO	# HOJAS	CALIBRE	ARCO LIBRE	LONGITUD LADO CORTO	LONGITUD LADO LARGO	BUJE LADO CORTO	BUJE LADO LARGO	PUNTA LADO CORTO	PUNTA LADO LARGO
3	1 / 1.375	-	4 3/4	21 1/4	22 5/8	-	-	 11	11 





KA71-156

INDUSTRIAS GONZÁLEZ

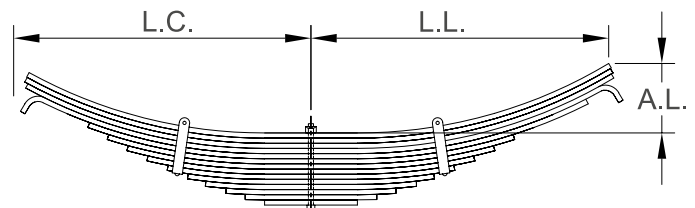
Muelle Trasera

- Aplicación: 2 Y 3 Eje Tandem #Original: B3208
- Modelo: 76-94 #Rassini: 71-156



ANCHO	# HOJAS	CALIBRE	ARCO LIBRE	LONGITUD LADO CORTO	LONGITUD LADO LARGO	BUJE LADO CORTO	BUJE LADO LARGO	PUNTA LADO CORTO	PUNTA LADO LARGO
3	15 / .499	-	4 5/8	22 3/4	22 3/4	-	-	 21	21 
	1A	-	4 5/8	22 3/4	22 3/4	-	-	 21	21 

KA55-1332

INTERNATIONAL

Muelle Delantera

- Aplicación: 55-1332 Supersided #Original: 3527263C91
55-1216 In Production #Rassini: 55-1216
- Capacidad: 5350 lb

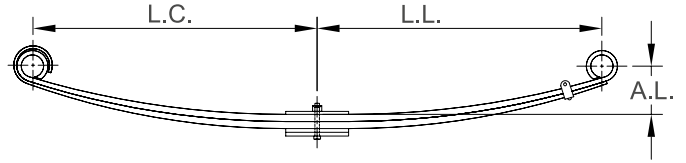

ANCHO	# HOJAS	CALIBRE	ARCO LIBRE	LONGITUD LADO CORTO	LONGITUD LADO LARGO	BUJE LADO CORTO	BUJE LADO LARGO	PUNTA LADO CORTO	PUNTA LADO LARGO
4	5 / .401,.788	.788	4 1/4	29	29	RB253	RB253	1	1
	1A	.788	4 1/4	29	29	RB253	RB253	1	1
	2A	.788	4 1/4	29	29	-	-	4	9

KA55-1238

INTERNATIONAL

Muelle Delantera

- Aplicación: 2 Leaf Taper Spring
3" Wide
- Capacidad: 3425 lb

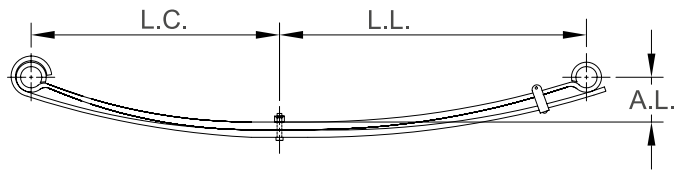

ANCHO	# HOJAS	CALIBRE	ARCO LIBRE	LONGITUD LADO CORTO	LONGITUD LADO LARGO	BUJE LADO CORTO	BUJE LADO LARGO	PUNTA LADO CORTO	PUNTA LADO LARGO
3	4 / .360,.788,.401	.788	3 1/2	25	29	RB270-B	RB270-B	2	2
	1A	.788	3 1/2	25	29	RB270	RB270	2	2
	2A	.788	3 1/2	25	29	RB270	RB270	4	9

KA55-1218

INTERNATIONAL

Muelle Delantera

- Aplicación: 14.0k Axle
- Capacidad: 6350 lb

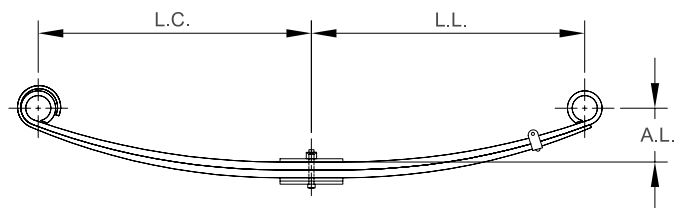

ANCHO	# HOJAS	CALIBRE	ARCO LIBRE	LONGITUD LADO CORTO	LONGITUD LADO LARGO	BUJE LADO CORTO	BUJE LADO LARGO	PUNTA LADO CORTO	PUNTA LADO LARGO
4	4 / .999,.323	.999	4	29	29	RB 253	RB 253	1	1
	1A	.999	4	29	29	RB 253	RB253	1	1
	2A	.999	4	29	29	-	-	4	9

KA55-1180

INTERNATIONAL

Muelle Delantera

- Aplicación: International Spring #Original: 1680499C91
- Capacidad: 3500 lb

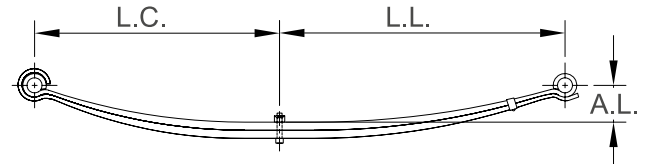

ANCHO	# HOJAS	CALIBRE	ARCO LIBRE	LONGITUD LADO CORTO	LONGITUD LADO LARGO	BUJE LADO CORTO	BUJE LADO LARGO	PUNTA LADO CORTO	PUNTA LADO LARGO
3	4 / .625, .702, .401	-	5	25	25	RB75	RB75	2	2

KA55-1176

INTERNATIONAL

Muelle Delantera

- Aplicación: International Usado en 14.0K AXLE
- Capacidad: 6350 lb

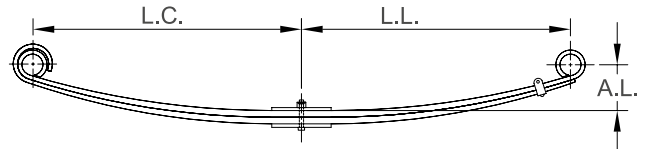

ANCHO	# HOJAS	CALIBRE	ARCO LIBRE	LONGITUD LADO CORTO	LONGITUD LADO LARGO	BUJE LADO CORTO	BUJE LADO LARGO	PUNTA LADO CORTO	PUNTA LADO LARGO
4	4 / .999, .323	1	4	29	29	TB26	TB26	1	1
	1A	1	4	29	29	TB26	TB26	1	1
	2A	1	4	29	29	-	-	4	9
	3A	-	4	31 1/2	31 1/2	-	-	21	21

KA55-1133

INTERNATIONAL

Muelle Zeta

- Aplicación: Make #Original: 1684471C91
- Capacidad: 8900 lb

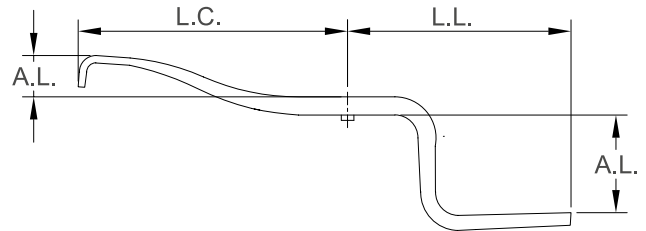

ANCHO	# HOJAS	CALIBRE	ARCO LIBRE	LONGITUD LADO CORTO	LONGITUD LADO LARGO	BUJE LADO CORTO	BUJE LADO LARGO	PUNTA LADO CORTO	PUNTA LADO LARGO
3 1/2	1 / 1.500	1.5	ESPECIAL	25 1/8	21 5/16	-	-	11	16

KA55-846-P

INTERNATIONAL

Muelle Delantera

- Aplicación: Dina 600 DOC #Rassini: 81-101-B
- Modelo: 94

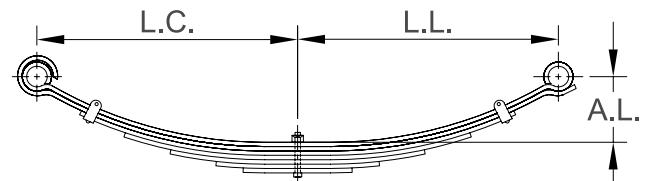

ANCHO	# HOJAS	CALIBRE	ARCO LIBRE	LONGITUD LADO CORTO	LONGITUD LADO LARGO	BUJE LADO CORTO	BUJE LADO LARGO	PUNTA LADO CORTO	PUNTA LADO LARGO
3	7 / .401	.401	4 1/2	25	25	RB75	RB75	2	2
	1A	.401	4 1/2	25	25	RB75	RB75	2	2
	2A	.401	4 1/2	25	25	-	-	7	8

KA55-898-P

INTERNATIONAL

Muelle Delantera

- Aplicación: Navistar Delantera #Original: 572379C91
- Modelo: 98 #Rassini: 81-181G
- Capacidad: 7200 lb

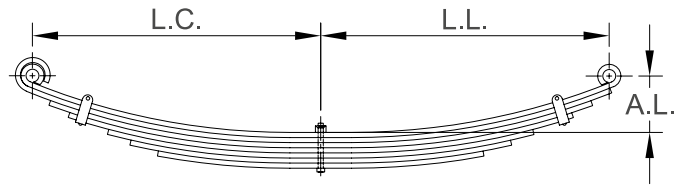

ANCHO	# HOJAS	CALIBRE	ARCO LIBRE	LONGITUD LADO CORTO	LONGITUD LADO LARGO	BUJE LADO CORTO	BUJE LADO LARGO	PUNTA LADO CORTO	PUNTA LADO LARGO
4	7 / .499	.499	5 1/2	25	29	RNK	RNK	1	1
	1A	.499	5 1/2	25	29	RNK	RNK	1	1
	2A	.499	5 1/2	25	29	-	-	4	10
	3A	.499	5 1/2	22 3/4	26	-	-	10	10
	3R	.499	5 1/2	25	28	-	-	10	10
	4A	.499	5 1/2	20	23	-	-	13	13
	5A	.499	5 1/2	15 1/2	18	-	-	10	10
	6A	.499	5 1/2	11	13	-	-	13	10
	7A	.499	5 1/2	7	7	-	-	10	10

KA55-144

INTERNATIONAL

Muelle Delantera

- Aplicación: International #Original: 1664618C91
- 12k Spring
- Capacidad: 5350 lb

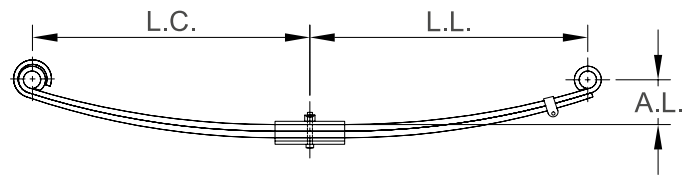

ANCHO	# HOJAS	CALIBRE	ARCO LIBRE	LONGITUD LADO CORTO	LONGITUD LADO LARGO	BUJE LADO CORTO	BUJE LADO LARGO	PUNTA LADO CORTO	PUNTA LADO LARGO
4	4/ .323,.788	.788	4 5/8	29	29	TB68	TB68	1	1
	1A	.788	4 5/8	29	29	-	-	1	1
	2A	.788	4 5/8	29	30	-	-	4	9

KA55-122

INTERNATIONAL

Muelle Delantera

- Aplicación: Series "S" Tandem #Original: 1654696
- E1900, 6x6, F2100,2200,2300,2600 #Rassini: 55-122
- Camión Escolar 1723,1823,1853
- Modelo: 87-UP

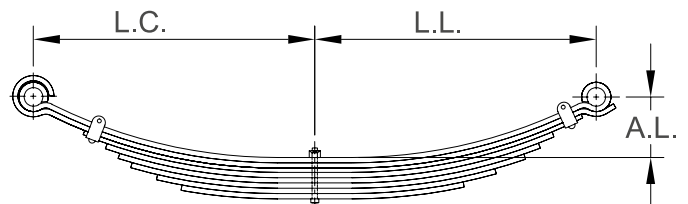

ANCHO	# HOJAS	CALIBRE	ARCO LIBRE	LONGITUD LADO CORTO	LONGITUD LADO LARGO	BUJE LADO CORTO	BUJE LADO LARGO	PUNTA LADO CORTO	PUNTA LADO LARGO
4	8 / .401	-	5 1/8	25	29	TB26	TB26	2	2
	1A	-	5 1/8	25	29	TB26	TB26	2	2
	2A	-	5 1/8	25	29	-	-	7	8

KA55-1195

INTERNATIONAL

Muelle Zeta

• Aplicación: Navistar
Use 55-1195

#Original:
501566C92

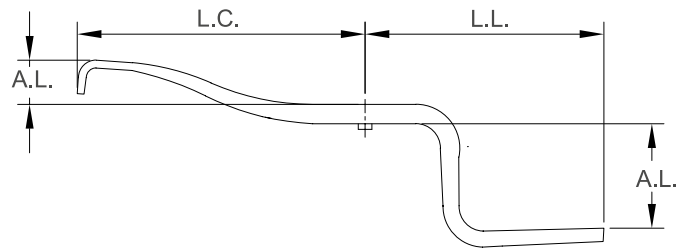

ANCHO	# HOJAS	CALIBRE	ARCO LIBRE	LONGITUD LADO CORTO	LONGITUD LADO LARGO	BUJE LADO CORTO	BUJE LADO LARGO	PUNTA LADO CORTO	PUNTA LADO LARGO
3 1/2	1 / 1.500	1.5	ESPECIAL	18 15/16	25 1/8	-	-	11	16

KA44-100E

INTERNATIONAL

Muelle Delantera

• Aplicación: International AI Spring

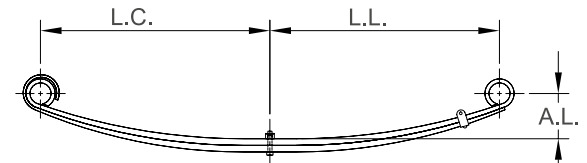

ANCHO	# HOJAS	CALIBRE	ARCO LIBRE	LONGITUD LADO CORTO	LONGITUD LADO LARGO	BUJE LADO CORTO	BUJE LADO LARGO	PUNTA LADO CORTO	PUNTA LADO LARGO
4	2 / .625	.625	6	25	29	TB26	TB26	2	2
	1A	.625	6	25	29	TB26	TB26	2	2
	2R	.625	6	25	29	-	-	7A	7A

KA56-450T

ISUZU

Muelle Trasera

• Aplicación: Isuzu ESPECIAL

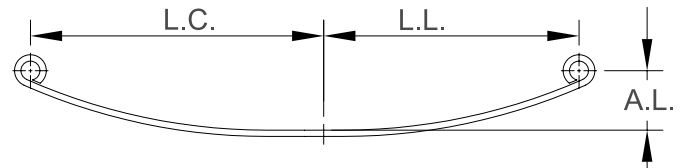

ANCHO	# HOJAS	CALIBRE	ARCO LIBRE	LONGITUD LADO CORTO	LONGITUD LADO LARGO	BUJE LADO CORTO	BUJE LADO LARGO	PUNTA LADO CORTO	PUNTA LADO LARGO
70 MM	1 / 13.10 MM	-	4	26 1/2	26 1/2	RB228	RB228	1	1
	1A	-	4	26 1/2	26 1/2	-	-	1	1

KA56-300T

ISUZU

Muelle Delantera

• Aplicación: Isuzu ESPECIAL

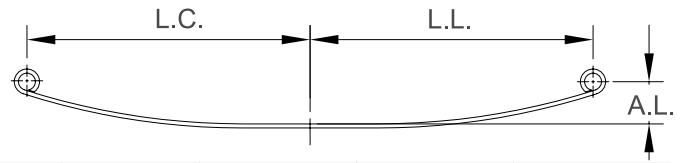

ANCHO	# HOJAS	CALIBRE	ARCO LIBRE	LONGITUD LADO CORTO	LONGITUD LADO LARGO	BUJE LADO CORTO	BUJE LADO LARGO	PUNTA LADO CORTO	PUNTA LADO LARGO
60 MM	1 / 9 MM	15	3	22 1/2	22 1/2	-	-	1	1
	1A	15	3	22 1/2	22 1/2	-	-	1	1

KA56-190

ISUZU

Muelle Delantera

- Aplicación: Isuzu
- Capacidad: 3825 lb

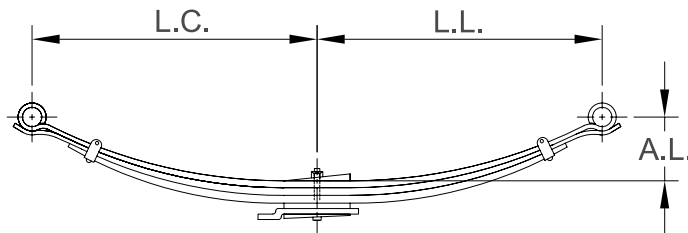

ANCHO	# HOJAS	CALIBRE	ARCO LIBRE	LONGITUD LADO CORTO	LONGITUD LADO LARGO	BUJE LADO CORTO	BUJE LADO LARGO	PUNTA LADO CORTO	PUNTA LADO LARGO
60 MM	3 / 15 MM	15	3 7/8	25 11/16	25 11/16	RB173	RB173	 2	2 
	1A	15	3 7/8	25 11/16	25 11/16	RB173	RB173	 2	2 
	2A	15	3 7/8	25 11/16	25 11/16	-	-	 7A	7A 
	3A	15	3 7/8	22 3/4	22 3/4	-	-	 13	13 

KA83-301

KENWORTH

Muelle Trasera

- Aplicación: Reyco-Kenworth
- Capacidad: 8500 lb

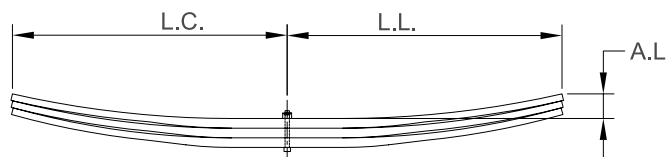

ANCHO	# HOJAS	CALIBRE	ARCO LIBRE	LONGITUD LADO CORTO	LONGITUD LADO LARGO	BUJE LADO CORTO	BUJE LADO LARGO	PUNTA LADO CORTO	PUNTA LADO LARGO
3	3 / .788, .499	-	5 3/8	22 3/8	22 1/8	-	-	 21	21 
	1A	-	5 3/8	22 3/8	22 1/8	-	-	 21	21 
	2A	-	5 3/8	22 3/8	22 1/8	-	-	 21	21 





KA71-157A

KENWORTH

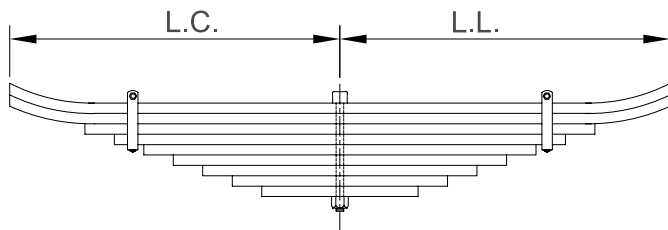
Muelle Trasera

- Aplicación: Tracto Camión
- Modelo: 63-83



ANCHO	# HOJAS	CALIBRE	ARCO LIBRE	LONGITUD LADO CORTO	LONGITUD LADO LARGO	BUJE LADO CORTO	BUJE LADO LARGO	PUNTA LADO CORTO	PUNTA LADO LARGO
4	9 / .625	.625	5 3/8	31	31	-	-	 21	21 
	1A	.625	5 3/8	31	31	-	-	 21	21 

KA71-157

KENWORTH

Muelle Trasera

- Aplicación: Tracto Camión C-622,SD-923-AD #Original: W223C34
- Modelo: 60-81 #Rassini: 71-157
- Capacidad: 3000 lb

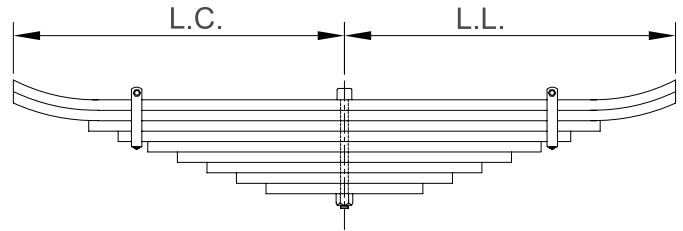

ANCHO	# HOJAS	CALIBRE	ARCO LIBRE	LONGITUD LADO CORTO	LONGITUD LADO LARGO	BUJE LADO CORTO	BUJE LADO LARGO	PUNTA LADO CORTO	PUNTA LADO LARGO
4	9 / .625	.625	3/8	28 1/2	28 1/2	-	-	 21	21 
	1A	.625	3/8	28 1/2	28 1/2	-	-	 21	21 
	2A	.625	3/8	23 3/4	23 3/4	-	-	 21	21 
	3A	.625	3/8	21	21	-	-	 13	13 
	4A	.625	3/8	18 1/4	18 1/4	-	-	 21	21 
	5A	.625	3/8	15 1/2	15 1/2	-	-	 21	21 
	6A	.625	3/8	12 7/8	12 7/8	-	-	 21	21 
	7A	.625	3/8	18 1/4	10 1/8	-	-	 21	21 
	8A	.625	3/8	7 1/2	7 1/2	-	-	 21	21 



KA70-138-P

KENWORTH

Muelle Delantera

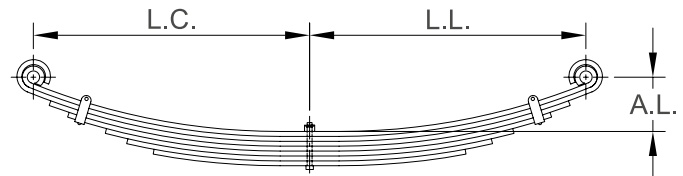
- Aplicación: Tracto Camión W-223-C300 #Original:
- Modelo: 67-89 #Rassini: 70-138



ANCHO	# HOJAS	CALIBRE	ARCO LIBRE	LONGITUD LADO CORTO	LONGITUD LADO LARGO	BUJE LADO CORTO	BUJE LADO LARGO	PUNTA LADO CORTO	PUNTA LADO LARGO
4	7 / .401	-	7 3/8	26 1/4	26 1/4	TB26	TB26	 1	1 
	1A	.401	7 3/8	26 1/4	26 1/4	TB26	TB26	 1	1 
	2A	.401	7 3/8	26 1/4	26 1/4	-	-	 4	4 
	3A	.401	7 3/8	24	24	-	-	 10	10 
	3R	.401	7 3/8	26	26	-	-	 10	10 
	4A	.401	7 3/8	18 1/2	18 1/2	-	-	 13	13 
	5A	.401	7 3/8	14 5/8	14 5/8	-	-	 10	10 
	6A	.401	7 3/8	10 3/4	10 3/4	-	-	 10	10 
	7A	.401	7 3/8	6 7/8	6 7/8	-	-	 10	10 





KA59-466A

KENWORTH

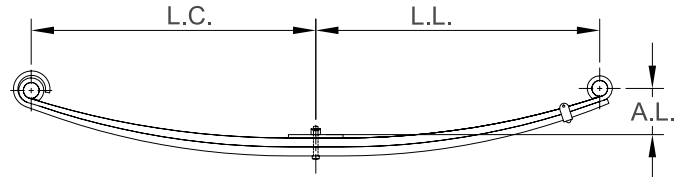
Muelle Delantera

- Modelo: 96-2000 #Original: HK48110-2709



ANCHO	# HOJAS	CALIBRE	ARCO LIBRE	LONGITUD LADO CORTO	LONGITUD LADO LARGO	BUJE LADO CORTO	BUJE LADO LARGO	PUNTA LADO CORTO	PUNTA LADO LARGO
4	2 / .999, .323	-	5	27	32 1/4	DT1474	DT1474	 1	1 
	1A	-	5	27	32 1/4	DT1474	DT1474	 1	1 







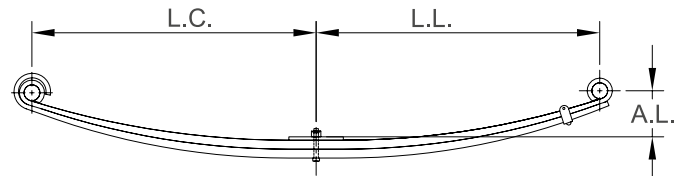

KA59-466

KENWORTH

Muelle Delantera

- Aplicación: Paquete Kenworth T300 #Original: HK48110-2709



ANCHO	# HOJAS	CALIBRE	ARCO LIBRE	LONGITUD LADO CORTO	LONGITUD LADO LARGO	BUJE LADO CORTO	BUJE LADO LARGO	PUNTA LADO CORTO	PUNTA LADO LARGO
4	3 / 1	-	5	27	32 1/4	TB26 ROSCADO	TB26 ROSCADO	 1	1 
	1A	-	5	27	32 1/4	TB26 ROSCADO	TB26 ROSCADO	 1	1 
	2A	-	5	27	32 1/4	-	-	 4	9 
	3A	-	5	27	32 1/4	-	-	 9	9 



KA59-450

KENWORTH

Muelle Delantera

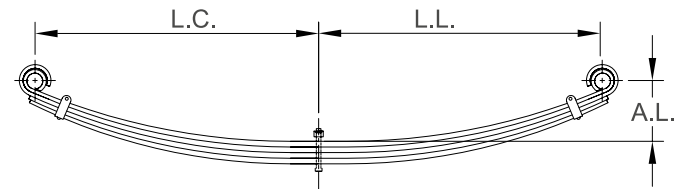
- Aplicación: Kenworth Full Tapersee Note #Original: HK481102200
- Capacidad: 9500 lb



ANCHO	# HOJAS	CALIBRE	ARCO LIBRE	LONGITUD LADO CORTO	LONGITUD LADO LARGO	BUJE LADO CORTO	BUJE LADO LARGO	PUNTA LADO CORTO	PUNTA LADO LARGO
4	4 / .999	-	3 1/2	32	32	TB68	TB68	 1	1 

KA59-428B

KENWORTH

Muelle Delantera

- Aplicación: Kenworth T800 2 Leaf Spring #Original: HK481101440
- Modelo: 05-11 #Rassini: 59-428

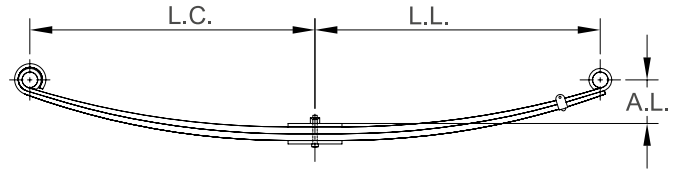

ANCHO	# HOJAS	CALIBRE	ARCO LIBRE	LONGITUD LADO CORTO	LONGITUD LADO LARGO	BUJE LADO CORTO	BUJE LADO LARGO	PUNTA LADO CORTO	PUNTA LADO LARGO
4	2 / .788	.788	5	32	32	RNK	TB26	1	1
	1A	.788	5	-	-	RNK	TB26	1	1

KA59-428

KENWORTH

Muelle Delantera

- Aplicación: Kenworth T800 2 Leaf Spring #Original: HK481101440
- Modelo: 05-11 #Rassini: 59-428
- Capacidad: 5600 lb

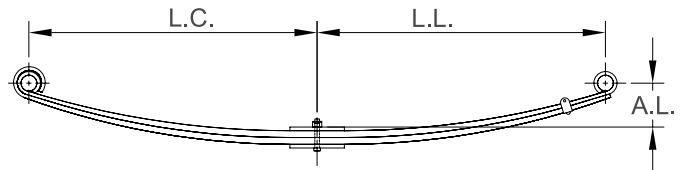

ANCHO	# HOJAS	CALIBRE	ARCO LIBRE	LONGITUD LADO CORTO	LONGITUD LADO LARGO	BUJE LADO CORTO	BUJE LADO LARGO	PUNTA LADO CORTO	PUNTA LADO LARGO
4	4 / .447, .999	.999	5	32	32	TB26	TB26	1	1
	1A	.999	5	32	32	TB26	TB26	1	1
	2A	.999	5	32	32	-	-	4	9

KA59-408

KENWORTH

Muelle Delantera

- Aplicación: Canadiense 12000 lb #Original: K2231125A
- Modelo: 82-06
- Capacidad: 5900 lb

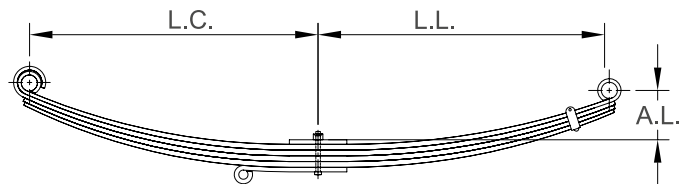

ANCHO	# HOJAS	CALIBRE	ARCO LIBRE	LONGITUD LADO CORTO	LONGITUD LADO LARGO	BUJE LADO CORTO	BUJE LADO LARGO	PUNTA LADO CORTO	PUNTA LADO LARGO
4	6 / .499, .625	.625	5 7/8	27 1/8	27 1/8	TB68	TB68	1	1
	1A	.625	5 7/8	27 1/8	27 1/8	TB68	TB68	1	1
	2A	.625	5 7/8	27 1/8	28 1/8	-	-	4	9









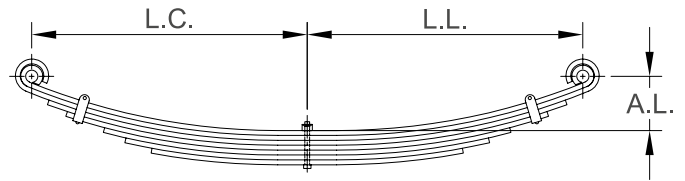



KA59-402

KENWORTH

Muelle Delantera

- Aplicación: Tracto Camión #Original: 35149217
- Modelo: 67-89



ANCHO	# HOJAS	CALIBRE	ARCO LIBRE	LONGITUD LADO CORTO	LONGITUD LADO LARGO	BUJE LADO CORTO	BUJE LADO LARGO	PUNTA LADO CORTO	PUNTA LADO LARGO
4	7 / .499	.499	8 1/2	32	32	TB26	TB26	 1	1 
	1A	.499	8 1/2	32	32	TB26	TB26	 1	1 
	2A	.499	8 1/2	32	32	-	-	 4	10 
	3A	.499	8 1/2	27	27	-	-	 10	10 
	4A	.499	8 1/2	24	24	-	-	 13	13 
	5A	.499	8 1/2	21	21	-	-	 10	10 









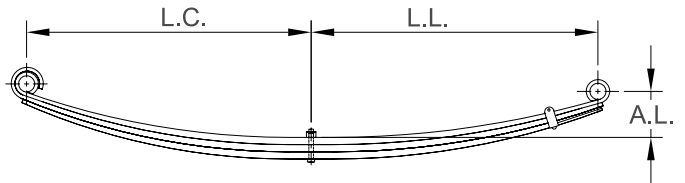

KA59-400

KENWORTH

Muelle Delantera

- Aplicación: Parabólica T450, T600, T800 #Original: K2231073-D
- Modelo: 90-94 #Rassini: 70-138-C
- Capacidad: 6560 lb



ANCHO	# HOJAS	CALIBRE	ARCO LIBRE	LONGITUD LADO CORTO	LONGITUD LADO LARGO	BUJE LADO CORTO	BUJE LADO LARGO	PUNTA LADO CORTO	PUNTA LADO LARGO
4	3 / .788	.75	5 1/8	32	32	TB26	TB26	 1	1 
	SA	.499	0	7 1/2	3 1/4	-	-	 1	21 
	1A	-	5 1/8	32	32	TB26	TB26	 1	1 
	2A	-	5 1/8	32	32	TB26	TB26	 4	9 
	3A	-	5 1/8	32	33	-	-	 9	9 





KA59-270-P7

KENWORTH

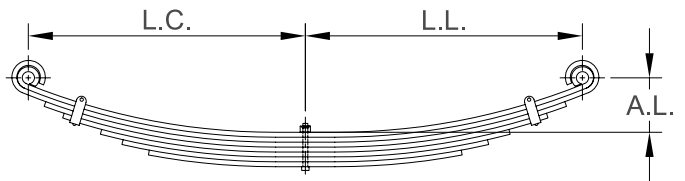
Muelle Delantera

- Aplicación: Tracto Camión #Original: K223965
- Modelo: 67-89
- Capacidad: 4900 lb



ANCHO	# HOJAS	CALIBRE	ARCO LIBRE	LONGITUD LADO CORTO	LONGITUD LADO LARGO	BUJE LADO CORTO	BUJE LADO LARGO	PUNTA LADO CORTO	PUNTA LADO LARGO
4	7 / .499	.75	5 1/2	27	27	TB26	TB26	 1	1 
	1A	.75	5 1/2	27	27	TB26	TB26	 1	1 
	2A	.75	5 1/2	27	27	-	-	 4	10 









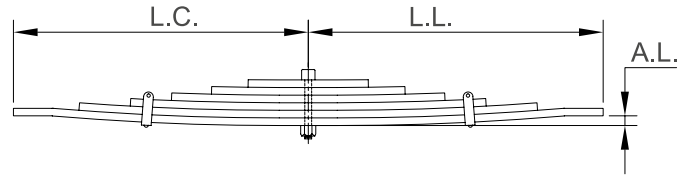



KA59-231

KENWORTH

Muelle Delantera

- Aplicación: Tracto Camión
 - Modelo: 82-94
 - Capacidad: 25020 lb
- #Original: K223C912
#Rassini: 71-157-B



ANCHO	# HOJAS	CALIBRE	ARCO LIBRE	LONGITUD LADO CORTO	LONGITUD LADO LARGO	BUJE LADO CORTO	BUJE LADO LARGO	PUNTA LADO CORTO	PUNTA LADO LARGO
4	6/.788,1	.999	2	30 1/2	30 1/2	-	-	 21	21 
	1A	.999	2	30 1/2	30 1/2	-	-	 21	21 
	2A	.75	2	23 1/16	23 1/16	-	-	 21	21 
	3A	.75	2	18 3/8	18 3/8	-	-	 13	13 
	4A	.75	2	14 1/8	14 1/8	-	-	 21	21 
	5A	.75	2	10	10	-	-	 21	21 

KAST-800

KENWORTH

Soportes para Transmisión

- Aplicación: Soporte Transmisión
 - Modelo: 90-98
- #Original: 4812373-CI
#Rassini: 70138A

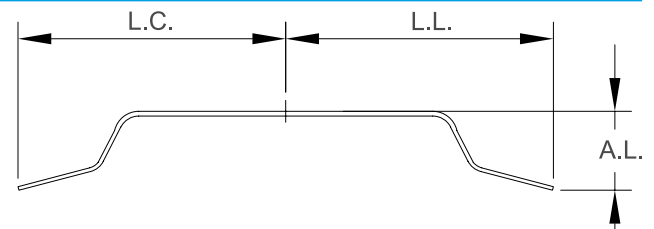

ANCHO	# HOJAS	CALIBRE	ARCO LIBRE	LONGITUD LADO CORTO	LONGITUD LADO LARGO	BUJE LADO CORTO	BUJE LADO LARGO	PUNTA LADO CORTO	PUNTA LADO LARGO
2	1/.360	.360	-	15 1/2	15 1/2	-	-	 13	13 





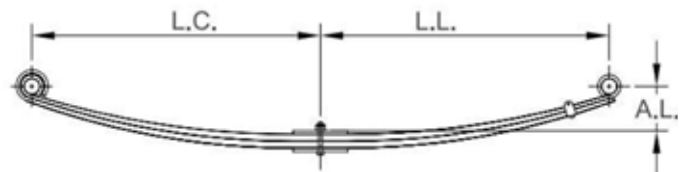

KA59-610

KENWORTH

Muelle Delantera

- Aplicación: T-300 Parabólica
- #Original: B81-6033



ANCHO	# HOJAS	CALIBRE	ARCO LIBRE	LONGITUD LADO CORTO	LONGITUD LADO LARGO	BUJE LADO CORTO	BUJE LADO LARGO	PUNTA LADO CORTO	PUNTA LADO LARGO
4	2/.788	-	6	24 7/8	29 5/8	RB338	RB338	 1	1 
	1A	-	6	24 7/8	29 5/8	RB338	RB338	 1	1 
	2A	-	6	24 7/8	30 1/2	-	-	 4	9 

KA71-157B5/8

KENWORTH

CG-22, SD-932 Y AJ21 con Guía

- Aplicación: Kenworth
- Modelo: 1995-1996



ANCHO	# HOJAS	CALIBRE	ARCO LIBRE	LONGITUD LADO CORTO	LONGITUD LADO LARGO	BUJE LADO CORTO	BUJE LADO LARGO	PUNTA LADO CORTO	PUNTA LADO LARGO
4	.625	-	ESP	30 1/2	30 1/2	-	-	 21	21 

KA71-157B3/4

KENWORTH

CG-22, SD-932 Y AJ21 con Guía

- Aplicación: Kenworth
- Modelo: 1995-1996



ANCHO	# HOJAS	CALIBRE	ARCO LIBRE	LONGITUD LADO CORTO	LONGITUD LADO LARGO	BUJE LADO CORTO	BUJE LADO LARGO	PUNTA LADO CORTO	PUNTA LADO LARGO
4	.75	-	ESP	30 1/2	30 1/2	-	-	 21	21 

KA83-257A

KENWORTH

Suspensión Reyco

- Aplicación: Y450
- Modelo: 1996-2000

#Original: 1996701



ANCHO	# HOJAS	CALIBRE	ARCO LIBRE	LONGITUD LADO CORTO	LONGITUD LADO LARGO	BUJE LADO CORTO	BUJE LADO LARGO	PUNTA LADO CORTO	PUNTA LADO LARGO
3	1.000	-	5.5	29	29	-	-	 21	21 

KA62-968

MACK

Muelle Delantera

- Aplicación: Mack Taper Spring RB188/RB1
- Capacidad: 5400 lb

#Original: 2QK3435M

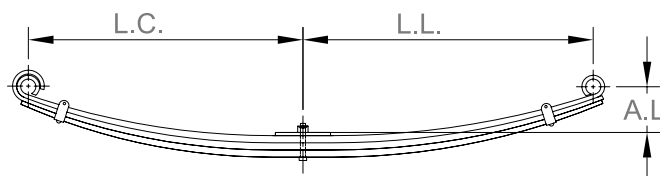

ANCHO	# HOJAS	CALIBRE	ARCO LIBRE	LONGITUD LADO CORTO	LONGITUD LADO LARGO	BUJE LADO CORTO	BUJE LADO LARGO	PUNTA LADO CORTO	PUNTA LADO LARGO
3 1/2	4 / .360 .788	.788	5 1/2	25 1/8	29 7/8	RB188	RB189	 1	1 

KA70-183-P9

MACK

Muelle Trasera

- Aplicación: Tractocamión #Original: 2QK334D
- Modelo: 80-83 #Rassini: 70-183

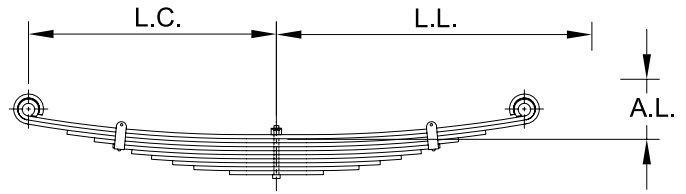

ANCHO	# HOJAS	CALIBRE	ARCO LIBRE	LONGITUD LADO CORTO	LONGITUD LADO LARGO	BUJE LADO CORTO	BUJE LADO LARGO	PUNTA LADO CORTO	PUNTA LADO LARGO
3 1/2	11 / .499	.499	5 5/8	25 1/8	29 7/8	RNI	TB69	1	1
	1A	.499	5 5/8	25 1/8	29 7/8	RNI	TB69	1	1
	2A	.499	5 5/8	25 1/8	29	-	-	4	10
	3A	.499	5 5/8	23	27 1/2	-	-	10	10
	4A	.499	5 5/8	20	24 1/2	-	-	10	10
	5A	.499	5 5/8	18 1/2	22	-	-	10	10
	6A	.499	5 5/8	16	19 1/2	-	-	10	10

KA62-1044

MACK

Muelle Delantera

- Aplicación: 2 Leaf Taper Spring #Original: 2QK4100
- 5,400
- Capacidad: 5400 lb

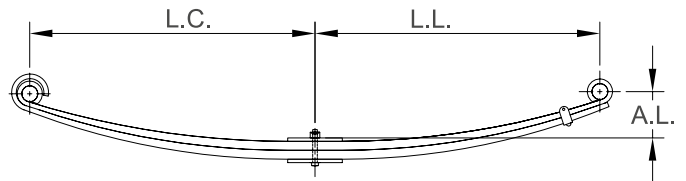

ANCHO	# HOJAS	CALIBRE	ARCO LIBRE	LONGITUD LADO CORTO	LONGITUD LADO LARGO	BUJE LADO CORTO	BUJE LADO LARGO	PUNTA LADO CORTO	PUNTA LADO LARGO
3 1/2	4 / .323 .887	.887	4 3/8	25 1/8	29 7/8	RB188	RB189	1	1
	1A	.887	4 3/8	25 1/8	29 7/8	RB188	RB188	1	1
	2A	.887	4 3/8	25 1/8	29 7/8	-	-	4	9

KA62-890

MACK

Muelle Delantera

- Aplicación: 13 Leaf Slipper Spring #Original: 2QK3377
- Capacidad: 9200 lb

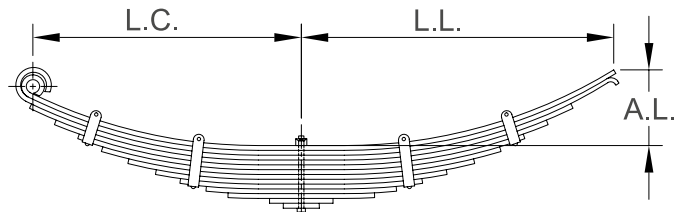

ANCHO	# HOJAS	CALIBRE	ARCO LIBRE	LONGITUD LADO CORTO	LONGITUD LADO LARGO	BUJE LADO CORTO	BUJE LADO LARGO	PUNTA LADO CORTO	PUNTA LADO LARGO
3 1/2	13 / .499	-	5	25 1/8	30 1/2	RNI	-	1	21

KA62-858

MACK

Muelle Delantera

- Aplicación: 4 Leaf Taper Spring 9300
- Capacidad: 9300 lb

#Original:
2QK3378P4

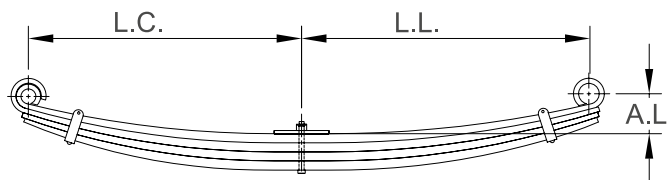

ANCHO	# HOJAS	CALIBRE	ARCO LIBRE	LONGITUD LADO CORTO	LONGITUD LADO LARGO	BUJE LADO CORTO	BUJE LADO LARGO	PUNTA LADO CORTO	PUNTA LADO LARGO
3 1/2	5 / .323, .850	-	4	25 1/8	29 7/8	MB1	TB69	1	1

KA62-856

MACK

Muelle Delantera

- Aplicación: 4 Leaf Taper Spring 11,500
- Capacidad: 11500 lb

#Original:
2QK3308A

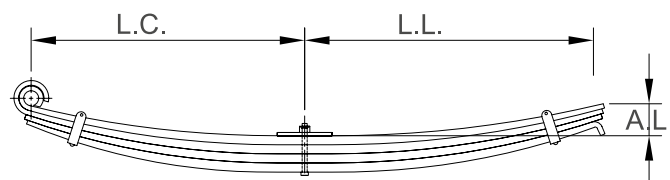

ANCHO	# HOJAS	CALIBRE	ARCO LIBRE	LONGITUD LADO CORTO	LONGITUD LADO LARGO	BUJE LADO CORTO	BUJE LADO LARGO	PUNTA LADO CORTO	PUNTA LADO LARGO
3 1/2	5 / .360, .917	-	3 7/8	25 1/8	30 1/2	RNI	-	1	21

KA62-832

MACK

Muelle Delantera

- Aplicación: 3 Leaf Taper Spring 8100
- Capacidad: 8100 lb

#Original:
2QK3378P3

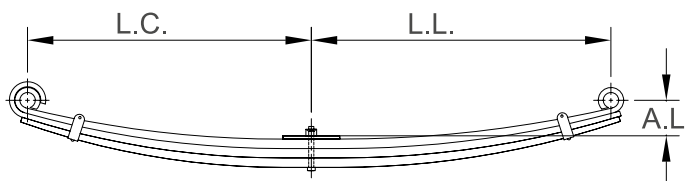

ANCHO	# HOJAS	CALIBRE	ARCO LIBRE	LONGITUD LADO CORTO	LONGITUD LADO LARGO	BUJE LADO CORTO	BUJE LADO LARGO	PUNTA LADO CORTO	PUNTA LADO LARGO
3 1/2	4 / .323, .910	-	3 3/4	25 1/8	29 7/8	MB1	TB69	1	1
	1A	-	3 3/4	25 1/8	29 7/8	MB1	TB69		
	2A	-	3 3/4	25 1/8	29 7/8	-	-		
	3A	-	3 3/4	26	30 3/4	-	-		

KA62-830

MACK

Muelle Delantera

- Aplicación: 3 Leaf Taper Spring 5,400
- Capacidad: 5400 lb
- #Original: 2QK3378P2

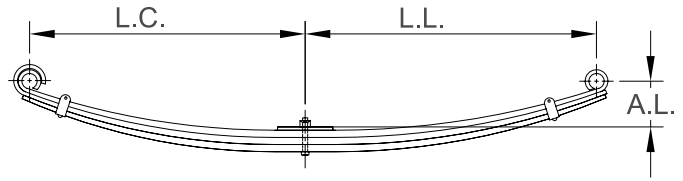

ANCHO	# HOJAS	CALIBRE	ARCO LIBRE	LONGITUD LADO CORTO	LONGITUD LADO LARGO	BUJE LADO CORTO	BUJE LADO LARGO	PUNTA LADO CORTO	PUNTA LADO LARGO
3 1/2	4 / .323, .715	-	4 3/4	25 1/8	29 7/8	MB1	TB69	1	1
	1A	-	4 3/4	25 1/8	29 7/8	MB1	TB69	1	1
	2A	-	4 3/4	25 1/8	29 7/8	-	-	4	9
	3A	-	4 3/4	26	30 3/4	-	-	9	9

KA62-808

MACK

Muelle Delantera

- Aplicación: 13 Leaf Slipper Spring
- Capacidad: 9200 lb
- #Original: 2QK3331

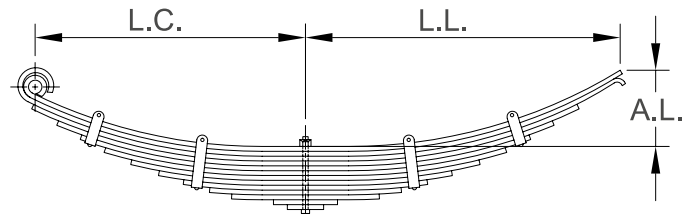

ANCHO	# HOJAS	CALIBRE	ARCO LIBRE	LONGITUD LADO CORTO	LONGITUD LADO LARGO	BUJE LADO CORTO	BUJE LADO LARGO	PUNTA LADO CORTO	PUNTA LADO LARGO
3 1/2	13 / .499	-	5	25 1/8	30 1/2	MB1	-	1	21

KA71-167C

MASA

Muelle Trasera

- Aplicación: Foraneo Premier
- Modelo: 91-99
- #Rassini: 71-167-E

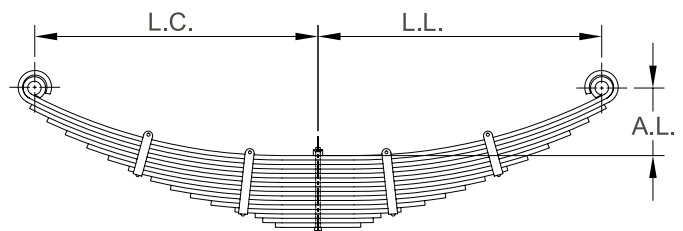

ANCHO	# HOJAS	CALIBRE	ARCO LIBRE	LONGITUD LADO CORTO	LONGITUD LADO LARGO	BUJE LADO CORTO	BUJE LADO LARGO	PUNTA LADO CORTO	PUNTA LADO LARGO
4	16	.499	9	37 1/16	37 1/16	RNK 1 1/2	RNK 1 1/2	1	1
	1A	.499	9	37 1/16	37 1/16	-	-	1	1
	2A	.499	9	37 1/16	37 1/16	-	-	4	4







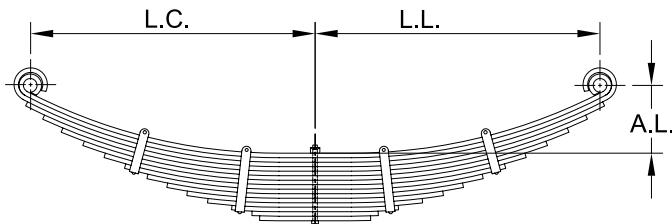

KA71-167

MASA

Muelle Trasera

- Aplicación: Autobus Foraneo #Original: 223208185
A-1 Somex #Rassini: 71-167
- Modelo: 80-84, 66-79



ANCHO	# HOJAS	CALIBRE	ARCO LIBRE	LONGITUD LADO CORTO	LONGITUD LADO LARGO	BUJE LADO CORTO	BUJE LADO LARGO	PUNTA LADO CORTO	PUNTA LADO LARGO
4	15 / .499	.499	7 1/4	33	33	RNK	RNK	 1	1 
	1A	.499	7 1/4	33	33	RNK	RNK	 1	1 
	2A	.499	7 1/4	33	33	-	-	 4	4 
	3A	.499	7 1/4	33	33	-	-	 10	10 

KA70-146

MASA

Muelle Delantera

- Aplicación: Autobus Foráneo #Original: 223108184
- Modelo: 66-83 #Rassini: 70-147

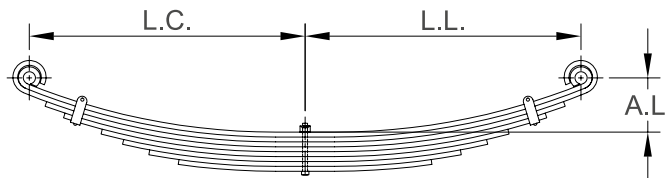

ANCHO	# HOJAS	CALIBRE	ARCO LIBRE	LONGITUD LADO CORTO	LONGITUD LADO LARGO	BUJE LADO CORTO	BUJE LADO LARGO	PUNTA LADO CORTO	PUNTA LADO LARGO
4	8 / .401	.401	6 1/2	28 9/16	28 9/16	RNK	RNK	 1	1 
	1A	.401	6 1/2	28 9/16	28 9/16	RNK	RNK	 1	1 
	2A	.401	6 1/2	28 9/16	28 9/16	-	-	 4	4 
	3A	.401	6 1/2	27	27	-	-	 10	10 
	4A	.401	6 1/2	24	24	-	-	 10	10 
	5A	.401	6 1/2	20 1/2	20 1/2	-	-	 13	13 
	6A	.401	6 1/2	17 5/16	17 5/16	-	-	 10	10 
	7A	.401	6 1/2	14 1/16	14 1/16	-	-	 10	10 

KA96-234-P









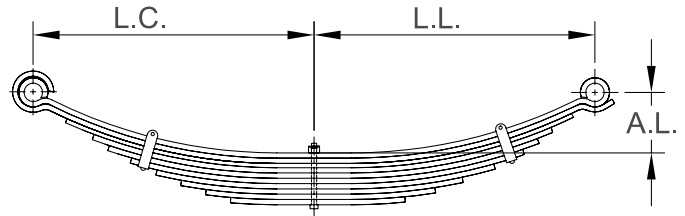





MERCEDES

Muelle Delantera

- Aplicación: Delantera
9,500 lb.
- Modelo: 1997

#Original:
LM6853202902
#Rassini: 44-140F



ANCHO	# HOJAS	CALIBRE	ARCO LIBRE	LONGITUD LADO CORTO	LONGITUD LADO LARGO	BUJE LADO CORTO	BUJE LADO LARGO	PUNTA LADO CORTO	PUNTA LADO LARGO
4	10 / .401	.401	5 1/2	28	33	NJK	NJK	 2	2 
	1A	.401	5 1/2	28	33	-	-	 2	2 
	2A	.401	5 1/2	28	33	-	-	 7	8 
	3A	.401	5 1/2	23	27	-	-	 10	10 
	3R	.401	5 1/2	25	29	-	-	 10	10 
	4A	.401	5 1/2	18	21	-	-	 13	13 
	5A	.401	5 1/2	13	15	-	-	 10	10 

KA96-234A





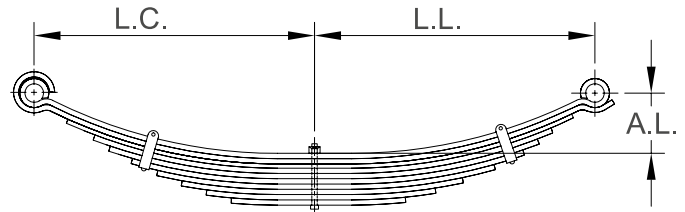

MERCEDES

Muelle Delantera

- Aplicación: Mercedes
Eurocar
- Modelo: 1997

#Original:
LM-685-3203602
#Rassini: 44-140-GM



ANCHO	# HOJAS	CALIBRE	ARCO LIBRE	LONGITUD LADO CORTO	LONGITUD LADO LARGO	BUJE LADO CORTO	BUJE LADO LARGO	PUNTA LADO CORTO	PUNTA LADO LARGO
4	2 / .401	.401	0	28	33	RNK	RNK	 2	2 
	1A	.401	0	28	33	-	-	 2	2 
	2A	.401	0	28	33	-	-	 7	8 









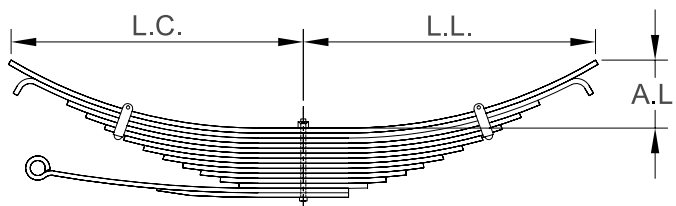













KA80-280A

MERCEDES

Muelle Trasera

- Aplicación: D-500, D-533, G-533-F Con Tirante



ANCHO	# HOJAS	CALIBRE	ARCO LIBRE	LONGITUD LADO CORTO	LONGITUD LADO LARGO	BUJE LADO CORTO	BUJE LADO LARGO	PUNTA LADO CORTO	PUNTA LADO LARGO
3	7 / .558 X 3	.558	5 1/2	38	38	RNG	-	 10	10 
	SOBRE TIRANTE	.499	-	3 1/2	35 1/2	-	-	 7	21 
	TIRANTE	.499	-	3 1/2	35 1/2	-	-	 2	21 
	1A	.558	5 1/2	38	38	-	-	 10	10 
	2A	.558	5 1/2	38 3/4	38 3/4	-	-	 18	18 
	3A	.558	5 1/2	32	32	-	-	 10	10 
	3R	.558	5 1/2	34	34	-	-	 10	10 
	4A	.558	5 1/2	28	28	-	-	 10	10 
	5A	.558	5 1/2	24	24	-	-	 13	13 
	6A	.558	5 1/2	19 1/2	19 1/2	-	-	 10	10 
	7A	.558	5 1/2	15 1/2	15 1/2	-	-	 10	10 









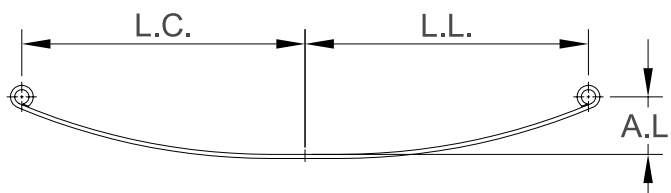



KA65-121

MERCEDES

Muelle Trasera

- Aplicación: Mercedes Truck Spring #Rassini: 45-200



ANCHO	# HOJAS	CALIBRE	ARCO LIBRE	LONGITUD LADO CORTO	LONGITUD LADO LARGO	BUJE LADO CORTO	BUJE LADO LARGO	PUNTA LADO CORTO	PUNTA LADO LARGO
3	.499	-	-	37 1/2	37 1/2	-	-	 1	1 
	1A	-	-	37 1/2	37 1/2	-	-	 1	1 
	2A	-	-	37 1/2	37 1/2	-	-	 4	9 
	3A	-	-	35 1/2	35 1/2	-	-	 21	21 
	4A	-	-	33 1/2	33 1/2	-	-	 21	21 
	5A	-	-	31 1/2	31 1/2	-	-	 21	21 

KA45-100A

MERCEDES

Muelle Trasera

- Aplicación: Camión Mercedes Torino
- Modelo: 04-05

#Original: 6853204605

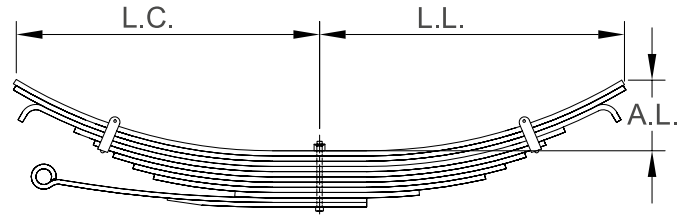

ANCHO	# HOJAS	CALIBRE	ARCO LIBRE	LONGITUD LADO CORTO	LONGITUD LADO LARGO	BUJE LADO CORTO	BUJE LADO LARGO	PUNTA LADO CORTO	PUNTA LADO LARGO
3	11 / .625	.625	7	38	38	-	-	21	21
	1A	.625	7	38	38	-	-	21	21
	2A	.625	7	38	38	-	-	21	21
	3A	.625	7	32	32	-	-	21	21
	4A	.625	7	28	28	-	-	21	21
	5A	.625	7	24	24	-	-	13	13
	6A	.625	7	20	20	-	-	21	21
	7A	.625	7	17	17	-	-	21	21

KA44-100D-P

MERCEDES

Muelle Delantera

- Aplicación: Autobus Mercedes Torino
- Modelo: 05-06

#Original: LM-685-3203602
#Rassini: 44-140-H

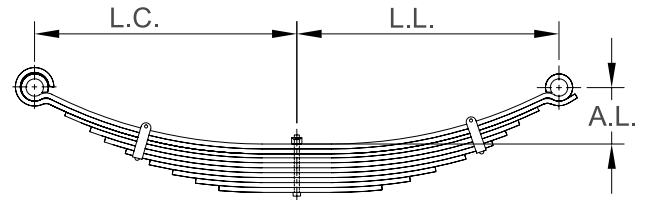

ANCHO	# HOJAS	CALIBRE	ARCO LIBRE	LONGITUD LADO CORTO	LONGITUD LADO LARGO	BUJE LADO CORTO	BUJE LADO LARGO	PUNTA LADO CORTO	PUNTA LADO LARGO
4	10 / .499	-	6	32	35	RNK	RNK	2	2
	1A	-	-	32	35	-	-	2	2
	2A	-	-	32	35	-	-	7	8
	3A	-	-	28	30	-	-	10	10
	4A	-	-	25	27	-	-	10	10
	5A	-	-	22	24	-	-	13	13
	6A	-	-	19	21	-	-	10	10
	7A	-	-	17	19	-	-	10	10
	8A	-	-	15	17	-	-	10	10
	9A	-	-	13	15	-	-	10	10

KA44-100C





MERCEDES

Muelle Delantera

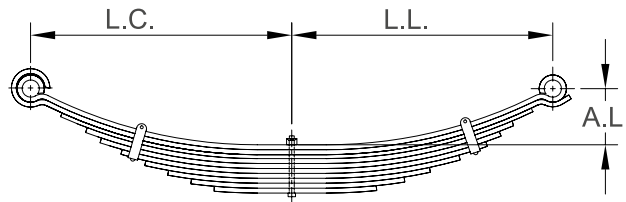
- Aplicación: Autobus Mercedes Torino
- Modelo: 2005-2006

#Original: LM-685-3203602
#Rassini: 44-140-H



ANCHO	# HOJAS	CALIBRE	ARCO LIBRE	LONGITUD LADO CORTO	LONGITUD LADO LARGO	BUJE LADO CORTO	BUJE LADO LARGO	PUNTA LADO CORTO	PUNTA LADO LARGO
4	.499	.499	6 3/4	32	35	NJK	NJK	 2	2 
	1A	.499	6 3/4	32	35	NJK	NJK	 2	2 
	2A	.499	6 3/4	32	35	-	-	 7	8 
	3A	.499	6 3/4	27	30	-	-	 10	10 
	4A	.499	6 3/4	23	24	-	-	 13	13 







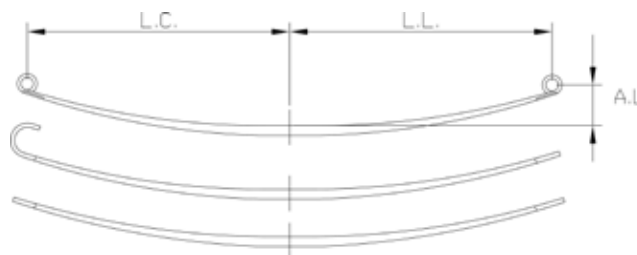

KA65-002

MERCEDES

Muelle Delantera

- Aplicación: Parabólica Boxer
- Modelo: 1999-2005



ANCHO	# HOJAS	CALIBRE	ARCO LIBRE	LONGITUD LADO CORTO	LONGITUD LADO LARGO	BUJE LADO CORTO	BUJE LADO LARGO	PUNTA LADO CORTO	PUNTA LADO LARGO
2.75	3/.984	-	4	34	34	NJG	NJG	 1	1 
	1A	-	4	34	34	NJG	NJG	 1	1 
	2A	-	4	34	35	-	-	 4	9 
	3A	-	4	35	35	-	-	 9	9 

KA80-280C-P15









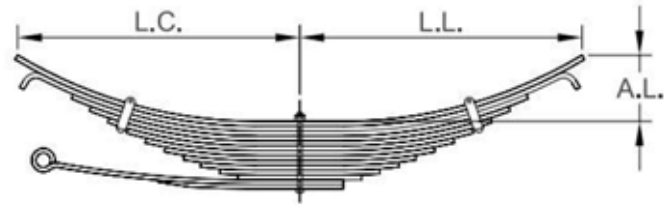













MERCEDES

Paquete Trasero

- Aplicación: Mercedes
- Modelo: 2006-2009

#Original: A-14532-19



ANCHO	# HOJAS	CALIBRE	ARCO LIBRE	LONGITUD LADO CORTO	LONGITUD LADO LARGO	BUJE LADO CORTO	BUJE LADO LARGO	PUNTA LADO CORTO	PUNTA LADO LARGO
3	15/.625	-	7 13/16	38	38	-	-	 10	10 
	1A	-	7 13/16	38	38	-	-	 10	10 
	2A	-	7 13/16	38	38	-	-	 18	18 
	3A	-	7 13/16	28 7/8	28 7/8	-	-	 10	10 
	4A	-	7 13/16	27 1/8	27 1/8	-	-	 10	10 
	5A	-	7 13/16	25 1/4	25 1/4	-	-	 13	13 
	6A	-	7 13/16	23 3/8	23 3/8	-	-	 10	10 
	7A	-	7 13/16	21 1/2	21 1/2	-	-	 10	10 
	8A	-	7 13/16	19 1/2	19 1/2	-	-	 10	10 
	9A	-	7 13/16	17 1/2	17 1/2	-	-	 10	10 
	10A	-	7 13/16	15	15	-	-	 13	13 
	11A	-	7 13/16	12 1/2	12 1/2	-	-	 10	10 
	12A	-	7 13/16	10	10	-	-	 10	10 
	13A	-	7 13/16	7 1/2	7 1/2	-	-	 2	21 
	14A	-	7 13/16	33	3 1/2	-	-	 2	21 
	15A	-	7 13/16	10	3 5/8	-	-	 10	21 







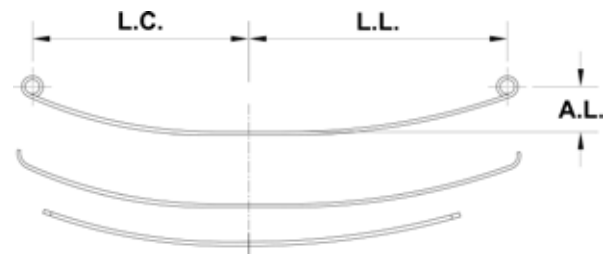

KA65-121

MERCEDES

Muelle

- Aplicación: Autobús OH Torino
- Modelo: 2010-2013



ANCHO	# HOJAS	CALIBRE	ARCO LIBRE	LONGITUD LADO CORTO	LONGITUD LADO LARGO	BUJE LADO CORTO	BUJE LADO LARGO	PUNTA LADO CORTO	PUNTA LADO LARGO
3	1/.375	-	4.125	37 1/2	37 1/2	M7-3630	M7-3630	 1	1 
	1A	-	4.125	37 1/2	37 1/2	-	-	 1	1 
	2A	-	4.125	37 1/2	37 1/2	-	-	 5	5 
	3A	-	4.125	38	38	-	-	 9	9 

KA65-1305
MERCEDES
Muelle Trasera

- Aplicación: Sprinter
- Modelo: 2004-2005

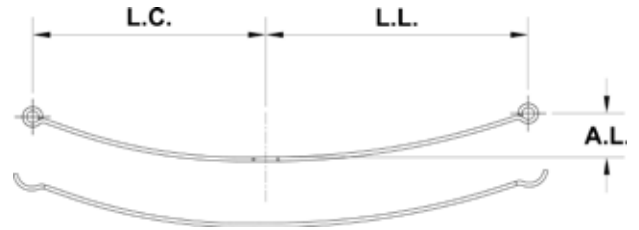

ANCHO	# HOJAS	CALIBRE	ARCO LIBRE	LONGITUD LADO CORTO	LONGITUD LADO LARGO	BUJE LADO CORTO	BUJE LADO LARGO	PUNTA LADO CORTO	PUNTA LADO LARGO
.70	13	-	6	29 1/4	29 1/4	1.84	1.86	 2	2 
	1A	-	6	29 1/4	29 1/4	-	-	 2	2 
	2R	-	6	29 1/4	29 1/4	-	-	 7A	7A 

KA36021417-P6
MUELLES PARA REMOLQUE LIGERO
Muelles Remolque Ligero

- Aplicación: Remolques Varios
- Capacidad: 6000 lb

#Rassini: E-5115

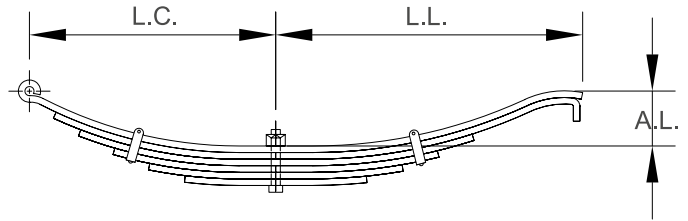

ANCHO	# HOJAS	CALIBRE	ARCO LIBRE	LONGITUD LADO CORTO	LONGITUD LADO LARGO	BUJE LADO CORTO	BUJE LADO LARGO	PUNTA LADO CORTO	PUNTA LADO LARGO
2	6 / .360	-	3	14	17	.700	PATIN	 1	21 
	1A	.360	3	14	17	.700	PATIN	 1	21 
	2A	.360	3	12 1/2	17	-	-	 21	18 
	3A	.360	3	11	11	-	-	 21	21 
	4A	.360	3	9	9	-	-	 21	21 
	5A	.360	3	7	7	-	-	 21	21 
	6A	.360	3	5	5	-	-	 21	21 

KASW-P6

MUELLES PARA REMOLQUE LIGERO

Muelles Remolque Ligero

- Aplicación: Remolques Varios #Original: 4342-117
- #Rassini: SW-6

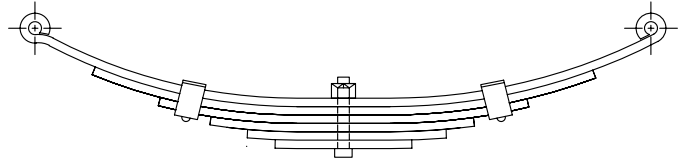

ANCHO	# HOJAS	CALIBRE	ARCO LIBRE	LONGITUD LADO CORTO	LONGITUD LADO LARGO	BUJE LADO CORTO	BUJE LADO LARGO	PUNTA LADO CORTO	PUNTA LADO LARGO
1 3/4	6 / .360	-	3	13 13/16	13 13/16	9/16	9/16	1	1
	1A	-	3 1/4	13 13/16	13 13/16	11/16	11/16	1	1
	2A	-	3	11	11	-	-	21	21
	2E	-	3 1/4	13 13/16	13 13/16	-	-	4	4
	2R	-	3	12 1/4	12 1/4	-	-	21	21
	2RG	-	3 1/4	13 13/16	13 13/16	-	-	5	5
	3A	-	3	8	8	-	-	13	13
	3R	-	3	9 1/2	9 1/2	-	-	21	21
	4A	-	3	5	5	-	-	21	21

KASW-P5

MUELLES PARA REMOLQUE LIGERO

Muelles Remolque Ligero

- Aplicación: Remolques Varios #Original: 4342-29
- #Rassini: SW-5

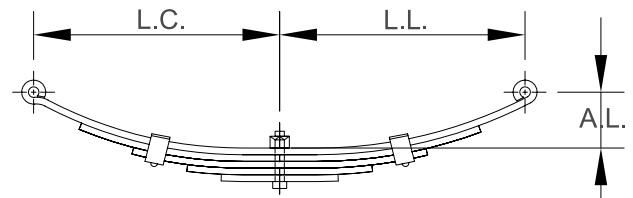

ANCHO	# HOJAS	CALIBRE	ARCO LIBRE	LONGITUD LADO CORTO	LONGITUD LADO LARGO	BUJE LADO CORTO	BUJE LADO LARGO	PUNTA LADO CORTO	PUNTA LADO LARGO
1 3/4	5 / .360	.360	3	13 13/16	13 13/16	ENP17	ENP17	1	1
	1A	-	3 1/4	13 13/16	13 13/16	11/16	11/16	1	1
	2A	-	3	11	11	-	-	21	21
	2E	-	3 1/4	13 13/16	13 13/16	-	-	4	4
	2R	-	3	12 1/4	12 1/4	-	-	21	21
	2RG	-	3 1/4	13 13/16	13 13/16	-	-	5	5
	3A	-	3	8	8	-	-	13	13
	4A	-	3	5	5	-	-	21	21

KASW-P4

MUELLES PARA REMOLQUE LIGERO

Muelles Remolque Ligero

• Aplicación: Remolques Varios

#Original: 4342-17
#Rassini: SW-4

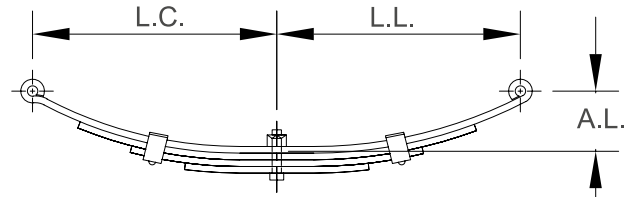

ANCHO	# HOJAS	CALIBRE	ARCO LIBRE	LONGITUD LADO CORTO	LONGITUD LADO LARGO	BUJE LADO CORTO	BUJE LADO LARGO	PUNTA LADO CORTO	PUNTA LADO LARGO
1 3/4	4 / .360	.360	3	13 3/16	13 3/16	ENP17	ENP17	1	1
	1A	.360	3	13 3/16	13 3/16	ENP17	ENP17	1	1
	2A	.360	3	11 1/2	11 1/2	-	-	21	21
	2E	.360	3	7 3/4	7 3/4	-	-	21	13
	2RG	.360	3	4 1/2	4 1/2	-	-	21	21

KAUNA-265

MUELLES PARA REMOLQUE LIGERO

Muelles Remolque Ligero

• Aplicación: Remolques Varios

#Original: 072-040

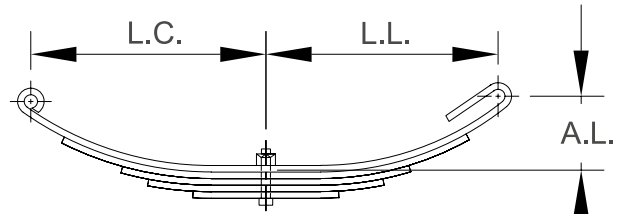

ANCHO	# HOJAS	CALIBRE	ARCO LIBRE	LONGITUD LADO CORTO	LONGITUD LADO LARGO	BUJE LADO CORTO	BUJE LADO LARGO	PUNTA LADO CORTO	PUNTA LADO LARGO
1 3/4	5 / .360	.360	3 1/2	13 3/4	14 1/8	9/16	-	1	4

KA55-1242

NAVISTAR

Muelle Delantera

• Aplicación: 2 Leaf Taper Spring 4" Wide
• Capacidad: 5350 lb

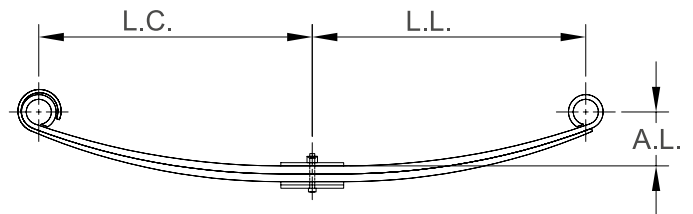

ANCHO	# HOJAS	CALIBRE	ARCO LIBRE	LONGITUD LADO CORTO	LONGITUD LADO LARGO	BUJE LADO CORTO	BUJE LADO LARGO	PUNTA LADO CORTO	PUNTA LADO LARGO
4	5 / .323,788	.788	4 3/16	25	29	RB253-B	RB253-B	2	2

KA55-1217

NAVISTAR

Muelle Trasera

- Aplicación: Single Axle Spring
10,400 S-600
- Capacidad: 10400 lb

#Original:
3534537C91
#Rassini: 81-190

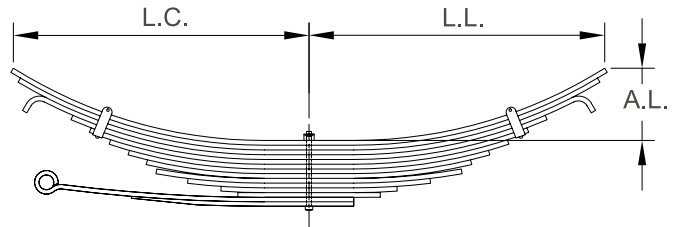

ANCHO	# HOJAS	CALIBRE	ARCO LIBRE	LONGITUD LADO CORTO	LONGITUD LADO LARGO	BUJE LADO CORTO	BUJE LADO LARGO	PUNTA LADO CORTO	PUNTA LADO LARGO
3	14 / .473,.499,.447	-	6 1/4	30 1/4	30 1/4	-	-	21	21

KA55-1197

NAVISTAR

Muelle Delantera

- Aplicación: 2 Stage Single Axle
Springcamion 431-K,531-E C/Tirante
- Modelo: 65-86
- Capacidad: 8200 lb

#Original:
A-3532-19
#Rassini: 80-220

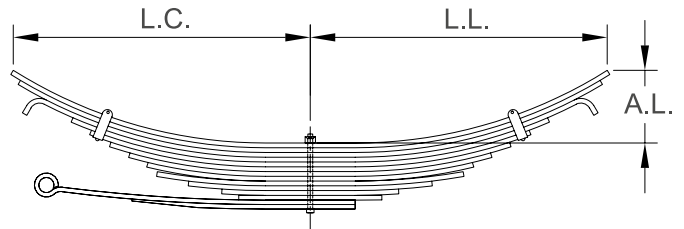

ANCHO	# HOJAS	CALIBRE	ARCO LIBRE	LONGITUD LADO CORTO	LONGITUD LADO LARGO	BUJE LADO CORTO	BUJE LADO LARGO	PUNTA LADO CORTO	PUNTA LADO LARGO
3	13 / .401,.499,.447	-	7 3/4	30 1/4	30 1/4	-	-	21	21

KA55-1195

NAVISTAR

Muelle Trasera

- Aplicación: Navistar "Z" Air
Ride Spring
- Capacidad: 8900 lb

#Original:
501566C93

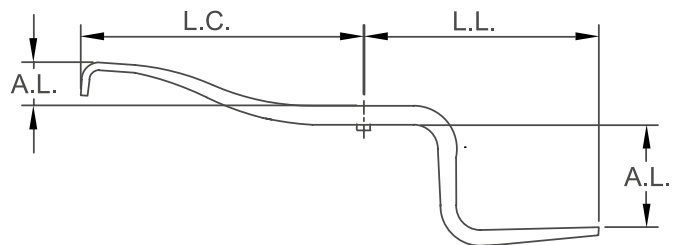

ANCHO	# HOJAS	CALIBRE	ARCO LIBRE	LONGITUD LADO CORTO	LONGITUD LADO LARGO	BUJE LADO CORTO	BUJE LADO LARGO	PUNTA LADO CORTO	PUNTA LADO LARGO
3 1/2	1 / 1.50	-	8 1/2	25 4/5	19 1/4	-	-	11	17

KA55-1192

NAVISTAR

Muelle Delantera

- Aplicación: Tracto S9400 12000 Lb #Original: 29996707-C92
- Modelo: 91-94 #Rassini: 81-140-F

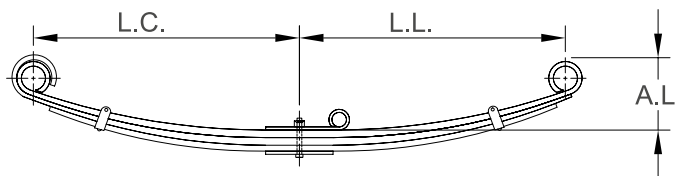

ANCHO	# HOJAS	CALIBRE	ARCO LIBRE	LONGITUD LADO CORTO	LONGITUD LADO LARGO	BUJE LADO CORTO	BUJE LADO LARGO	PUNTA LADO CORTO	PUNTA LADO LARGO
4	3 / .625	.625	5 7/8	25	29	RNK	RNK	 1	1 
	1A	.625	5 7/8	25	29	RNK	-	 1	1 
	2A	.625	5 7/8	25	29	-	-	 4	9 
	3A	.625	5 7/8	25	30	-	-	 9	9 

KA55-944

NAVISTAR

Muelle Delantera

- Aplicación: Front Spring 20.0k S-700 #Original: 533563C91
- Modelo: 94-98 #Rassini: 81-140-G
- Capacidad: 9100 lb

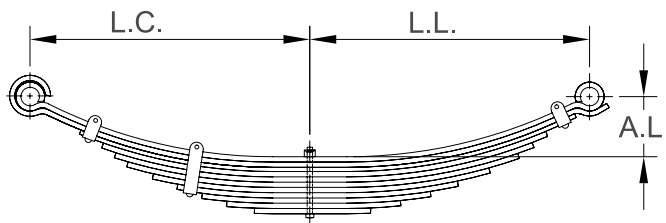

ANCHO	# HOJAS	CALIBRE	ARCO LIBRE	LONGITUD LADO CORTO	LONGITUD LADO LARGO	BUJE LADO CORTO	BUJE LADO LARGO	PUNTA LADO CORTO	PUNTA LADO LARGO
4	11 / .499	-	4 3/8	25	29	RNK-B	RNK-B	 2	2 

KA55-930

NAVISTAR

Muelle Delantera

- Aplicación: Co9670 Taper Spring Tb26 B #Original: 588204C1
- Capacidad: 5350 lb

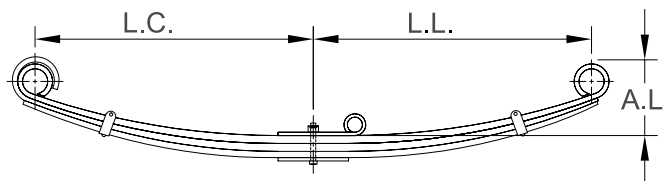

ANCHO	# HOJAS	CALIBRE	ARCO LIBRE	LONGITUD LADO CORTO	LONGITUD LADO LARGO	BUJE LADO CORTO	BUJE LADO LARGO	PUNTA LADO CORTO	PUNTA LADO LARGO
4	5 / .360, .662, .360	-	5 3/4	25	29	TB26	TB26	 1	1 

KA55-894

NAVISTAR

Muelle Delantera

- Aplicación: S Series Spring 3500 S-400 #Original: 572355C91
- Modelo: 89-94 #Rassini: 81-100E

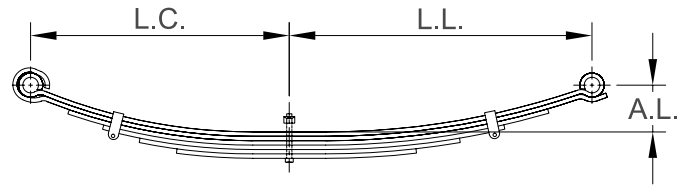

ANCHO	# HOJAS	CALIBRE	ARCO LIBRE	LONGITUD LADO CORTO	LONGITUD LADO LARGO	BUJE LADO CORTO	BUJE LADO LARGO	PUNTA LADO CORTO	PUNTA LADO LARGO
3	6 / .447,.401,.323	-	4	25	25	RB75-B	RB75-B	2	2

KA55-160

NAVISTAR

Muelle Delantera

- Aplicación: Front Spring 18.0k #Original: 1667488C92
- Capacidad: 8100 lb

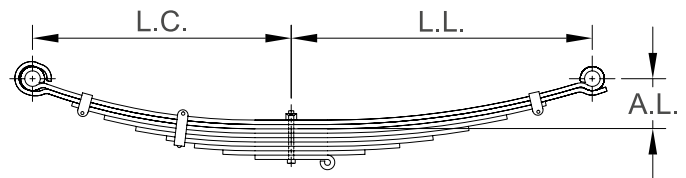

ANCHO	# HOJAS	CALIBRE	ARCO LIBRE	LONGITUD LADO CORTO	LONGITUD LADO LARGO	BUJE LADO CORTO	BUJE LADO LARGO	PUNTA LADO CORTO	PUNTA LADO LARGO
4	8 / .527,.499,.401	.499	4	25	29	RNK-B	RNK-B	2	2

KA55-148-P

NAVISTAR

Muelle Delantera

- Aplicación: Front Spring 12.0k #Original: 1661469C91
- Modelo: 00-03 #Rassini: 55-148
- Capacidad: 5350 lb

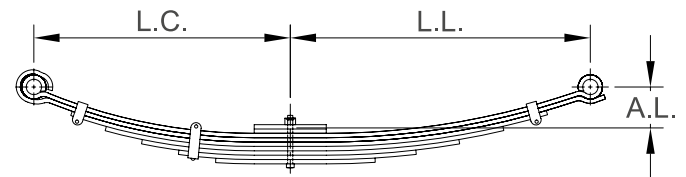

ANCHO	# HOJAS	CALIBRE	ARCO LIBRE	LONGITUD LADO CORTO	LONGITUD LADO LARGO	BUJE LADO CORTO	BUJE LADO LARGO	PUNTA LADO CORTO	PUNTA LADO LARGO
4	9 / .423	.423	5	25	29	RNK-B	RNK-B	2	2
	1A	.423	5	25	29	-	-	2	2
	2A	.423	5	25	29	-	-	7	8
	3A	.423	5	21 1/4	24 3/4	-	-	13	13
	4A	.423	5	17 5/8	20 3/8	-	-	10	10
	5A	.423	5	14	16	-	-	10	10
	6A	.423	5	10 3/8	11 3/4	-	-	10	10
	7A	.423	5	6 3/4	7 1/2	-	-	10	10
	8A	.423	5	3 1/4	3 1/4	-	-	21	21

KA55-041
NAVISTAR
Muelle Trasera

- Aplicación: Single Axle 14 Leaf Spring S-1900 #Original: 492803C91
- Modelo: 79-89 #Rassini: 45-100-L
- Capacidad: 8820 lb

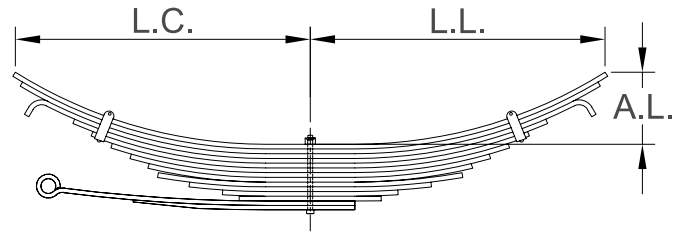

ANCHO	# HOJAS	CALIBRE	ARCO LIBRE	LONGITUD LADO CORTO	LONGITUD LADO LARGO	BUJE LADO CORTO	BUJE LADO LARGO	PUNTA LADO CORTO	PUNTA LADO LARGO
3	14 / .473,.360,.447	-	6 1/4	30 1/4	30 1/4	-	-	21	21

KA55-037
NAVISTAR
Muelle Trasera

- Aplicación: 4 Leaf Helper Spring #Original: 2992721C91
- Modelo: 90-92 #Rassini: 81-160
- Capacidad: 2250 lb

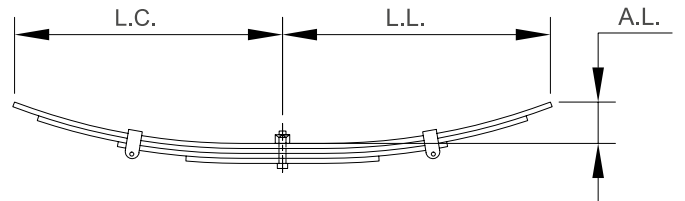

ANCHO	# HOJAS	CALIBRE	ARCO LIBRE	LONGITUD LADO CORTO	LONGITUD LADO LARGO	BUJE LADO CORTO	BUJE LADO LARGO	PUNTA LADO CORTO	PUNTA LADO LARGO
3	4 / .360	-	3	19 3/4	19 3/4	-	-	21	21

KA55-035
NAVISTAR
Muelle Trasera

- Aplicación: Single Axle 14 Leaf Spring S-1900 #Original: 471292C91
- Modelo: 89-98 #Rassini: 45-100

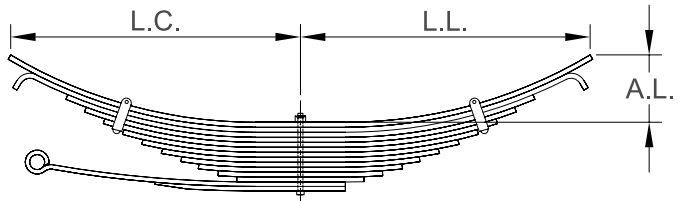

ANCHO	# HOJAS	CALIBRE	ARCO LIBRE	LONGITUD LADO CORTO	LONGITUD LADO LARGO	BUJE LADO CORTO	BUJE LADO LARGO	PUNTA LADO CORTO	PUNTA LADO LARGO
3	14 / .447,.499	-	6 1/4	30 1/4	30 1/4	-	-	21	21

KA55-031
NAVISTAR
Muelle Trasera

- Aplicación: Single Axle 13 Leaf Spring S-600 #Original: 471287C91
- Modelo: 91-94 #Rassini: 81-190

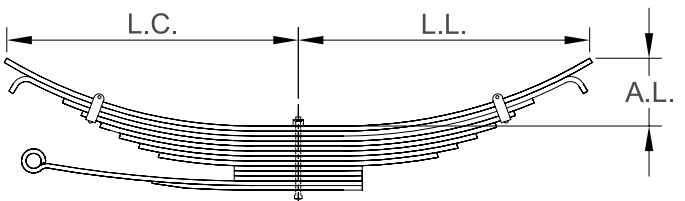

ANCHO	# HOJAS	CALIBRE	ARCO LIBRE	LONGITUD LADO CORTO	LONGITUD LADO LARGO	BUJE LADO CORTO	BUJE LADO LARGO	PUNTA LADO CORTO	PUNTA LADO LARGO
3	13 / .447,.499	-	6 1/4	30 1/4	30 1/4	-	-	21	21

KA55-029

NAVISTAR

Muelle Trasera

- Aplicación: Single Axle 14 Leaf Spring S-1900 #Original: 471292C91
- Modelo: 89-98 Leaf Spring S-1900 #Rassini: 45-100

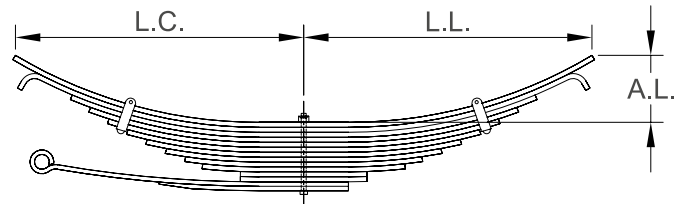

ANCHO	# HOJAS	CALIBRE	ARCO LIBRE	LONGITUD LADO CORTO	LONGITUD LADO LARGO	BUJE LADO CORTO	BUJE LADO LARGO	PUNTA LADO CORTO	PUNTA LADO LARGO
3	14 / .447,.499	-	6 1/4	30 1/4	30 1/4	-	-	21	21

KA55-021-P

NAVISTAR

Muelle Trasera

- Aplicación: Caja Navistar #Original: USM-0552
- Modelo: 66-94 #Rassini: 80-200
- Capacidad: 7860 lb

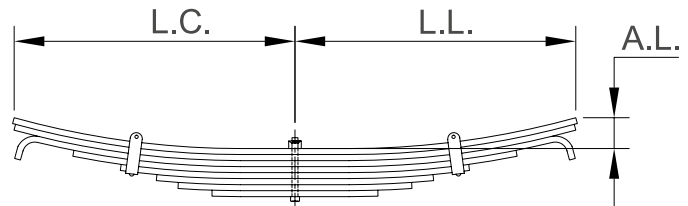

ANCHO	# HOJAS	CALIBRE	ARCO LIBRE	LONGITUD LADO CORTO	LONGITUD LADO LARGO	BUJE LADO CORTO	BUJE LADO LARGO	PUNTA LADO CORTO	PUNTA LADO LARGO
3 1/2	8 / .499	.499	3	23	25	-	-	10	10
	1A	.499	3	23	25	-	-	10	10
	2A	.499	3	23 5/8	23 5/8	-	-	18	18
	3A	.499	3	19 7/8	21 7/8	-	-	10	10
	4A	.499	3	15 3/4	17 13/16	-	-	13	13
	5A	.499	3	13 9/16	15	-	-	10	10
	6A	.499	3	11 3/16	12 1/4	-	-	10	10
	7A	.499	3	9 1/16	9 1/16	-	-	10	10
	8A	.499	3	6 3/8	6 3/8	-	-	10	10

KATRA-3223

NEWAY

Muelle Trasera

- Aplicación: Neway 5-Leaf Spring #Original: 91557272, Neway Ts4440 Suspensión
- Capacidad: 19500 lb

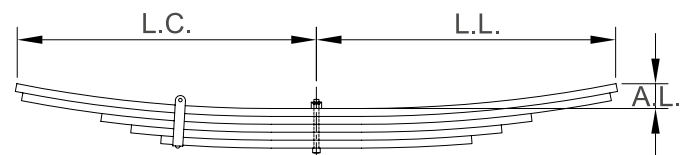

ANCHO	# HOJAS	CALIBRE	ARCO LIBRE	LONGITUD LADO CORTO	LONGITUD LADO LARGO	BUJE LADO CORTO	BUJE LADO LARGO	PUNTA LADO CORTO	PUNTA LADO LARGO
5	5 / .887	.887	1 3/4	27 5/8	27 5/8	-	-	13	13
	1A	-	-	27 5/8	27 5/8	-	-	13	13

KATRA-3222





NEWAY

Muelle Trasera

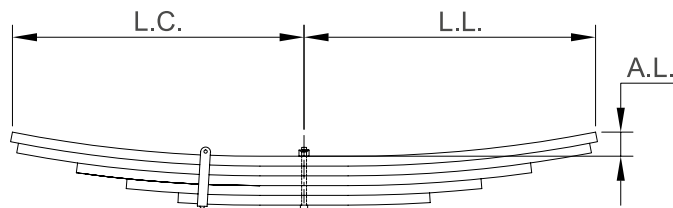
- Aplicación: Neway 5-Leaf Spring 91557273, Neway Ts-5500 Suspensión
- Capacidad: 23500 lb

#Original:
91557273



ANCHO	# HOJAS	CALIBRE	ARCO LIBRE	LONGITUD LADO CORTO	LONGITUD LADO LARGO	BUJE LADO CORTO	BUJE LADO LARGO	PUNTA LADO CORTO	PUNTA LADO LARGO
5	5 / .999	.999	2 1/8	28 7/8	28 7/8	-	-	 13	13 
	1A	.999	2 1/8	28 7/8	28 7/8	-	-	 13	13 

KA80-180H





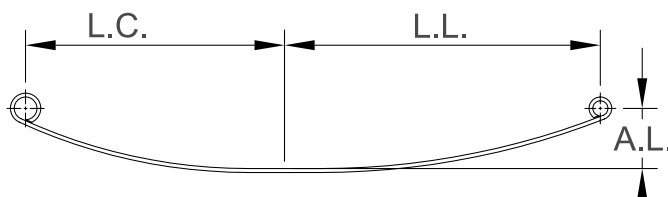

NISSAN

Muelle Trasera

- Aplicación: Urban
- Modelo: 2002

#Rassini: 20822-NT1



ANCHO	# HOJAS	CALIBRE	ARCO LIBRE	LONGITUD LADO CORTO	LONGITUD LADO LARGO	BUJE LADO CORTO	BUJE LADO LARGO	PUNTA LADO CORTO	PUNTA LADO LARGO
2 1/4	1 / .323	.323	5	22 1/2	27	-	-	 1	1 
	1A	.323	5	22 1/2	27	-	-	 1	1 
	2R	.323	5	24 3/8	28 7/8	-	-	 5	5 



KA80-180G

NISSAN

Muelle Trasera

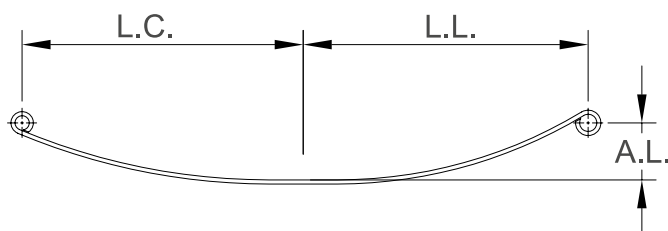
- Aplicación: X-Terra
- Modelo: 2002



ANCHO	# HOJAS	CALIBRE	ARCO LIBRE	LONGITUD LADO CORTO	LONGITUD LADO LARGO	BUJE LADO CORTO	BUJE LADO LARGO	PUNTA LADO CORTO	PUNTA LADO LARGO
2 1/4	1 / .323	.323	5	25 1/2	25 1/2	-	-	 1	3 
	1A	.323	5	25 1/2	25 1/2	-	-	 1	3 

KA80-180E

NISSAN

Muelle Trasera

- Aplicación: Cw Ichivan
- Modelo: 86-94

#Original: 55020C07G0
#Rassini: 80-180E

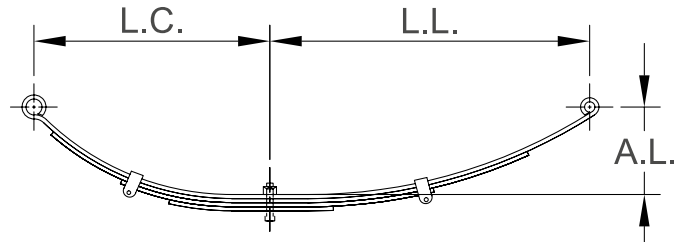

ANCHO	# HOJAS	CALIBRE	ARCO LIBRE	LONGITUD LADO CORTO	LONGITUD LADO LARGO	BUJE LADO CORTO	BUJE LADO LARGO	PUNTA LADO CORTO	PUNTA LADO LARGO
2 1/4	4 / .323	.323	5 3/8	20 1/4	25	RB760B	1 1/8	1	1
	1A	.323	5 3/8	20 1/4	25	RB760B	1 1/8	1	1
	2A	.323	5 3/8	17 1/4	22	-	-	10	10

KA80-180D

NISSAN

Muelle Trasera

- Aplicación: Cw-Ichivan
- Modelo: 86-98

#Original: 54010C07G0
#Rassini: 80-180-F

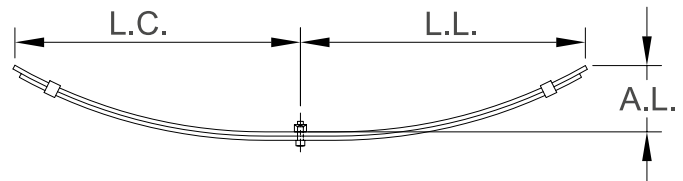

ANCHO	# HOJAS	CALIBRE	ARCO LIBRE	LONGITUD LADO CORTO	LONGITUD LADO LARGO	BUJE LADO CORTO	BUJE LADO LARGO	PUNTA LADO CORTO	PUNTA LADO LARGO
3	2 / .360	.360	4 5/8	23	23	-	-	20	20
	1A	.360	4 5/8	23	23	-	-	20	20
	2A	.360	4 5/8	22	22	-	-	19	19

KA80-180

NISSAN

Muelle Trasera

- Aplicación: Pick Up
- Modelo: 66-72

#Original: 5502020500
#Rassini: 80-180

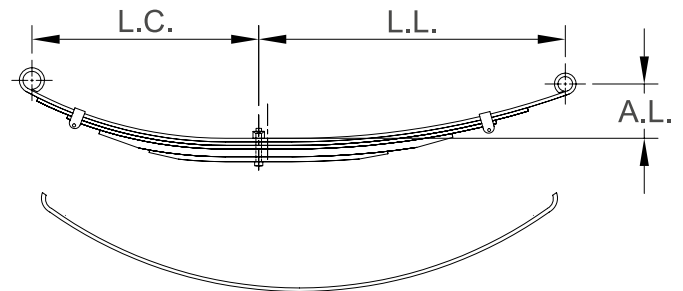



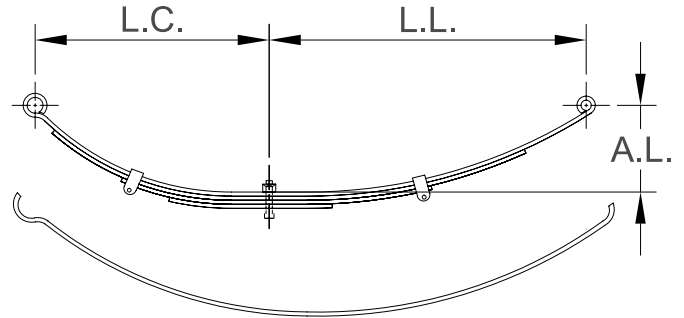

ANCHO	# HOJAS	CALIBRE	ARCO LIBRE	LONGITUD LADO CORTO	LONGITUD LADO LARGO	BUJE LADO CORTO	BUJE LADO LARGO	PUNTA LADO CORTO	PUNTA LADO LARGO
2 1/4	5 / .323	.323	5 1/4	21 11/16	25 9/16	RB70A	RB762	1	1
	1A	.323	5 1/4	21 11/16	25 9/16	RB70A	RB762	1	1
	2R	.323	5 1/4	23 9/16	27 1/16	-	-	5	5

KA80-140
NISSAN
Muelle Trasera

- Aplicación: Sedan 1500-1600 #Original: 5502021213
- Modelo: 66-75 #Rassini: 80-140





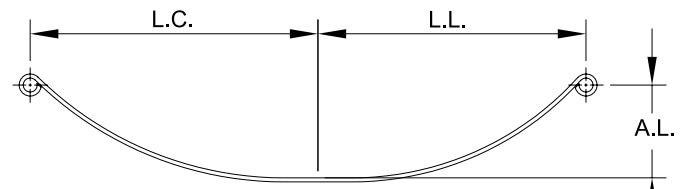

ANCHO	# HOJAS	CALIBRE	ARCO LIBRE	LONGITUD LADO CORTO	LONGITUD LADO LARGO	BUJE LADO CORTO	BUJE LADO LARGO	PUNTA LADO CORTO	PUNTA LADO LARGO
2 1/4	4 / .323	-	6 7/8	20 11/16	26 9/16	RB760B	13/16	 2	1 
	1A	-	6 7/8	20 11/16	26 9/16	RB760B	13/16	 2	1 

KA69-2011T
NISSAN
Muelle Trasera

- Aplicación: Frontier
- Modelo: 2011



ANCHO	# HOJAS	CALIBRE	ARCO LIBRE	LONGITUD LADO CORTO	LONGITUD LADO LARGO	BUJE LADO CORTO	BUJE LADO LARGO	PUNTA LADO CORTO	PUNTA LADO LARGO
60 MM	1 / 9 MM	9 MM	8 1/4	27 1/4	25 5/8	-	-	 3	2 
	1A	9 MM	8 1/4	27 1/4	25 5/8	-	-	 3	2 

KA69-277
NISSAN
Muelle Trasera

- Aplicación: Frontier 4 X 2
- Modelo: 98-04
- Capacidad: 1250 lb

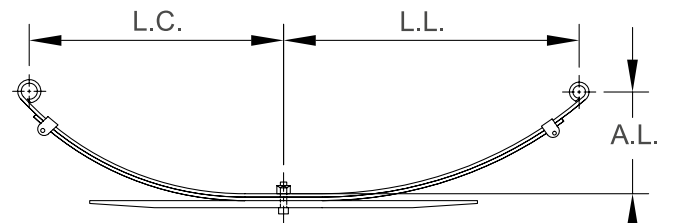

ANCHO	# HOJAS	CALIBRE	ARCO LIBRE	LONGITUD LADO CORTO	LONGITUD LADO LARGO	BUJE LADO CORTO	BUJE LADO LARGO	PUNTA LADO CORTO	PUNTA LADO LARGO
2 1/3	3 / 7.0,14.0	-	7 1/2	23 5/8	23 3/4	RB201	HB1109	 1	1 

KA69-257

NISSAN

Muelle Trasera

- Aplicación: Frontier / X-Terra 4 Leaf #Original: 550207Z101
- Modelo: 98-04
- Capacidad: 1250 lb

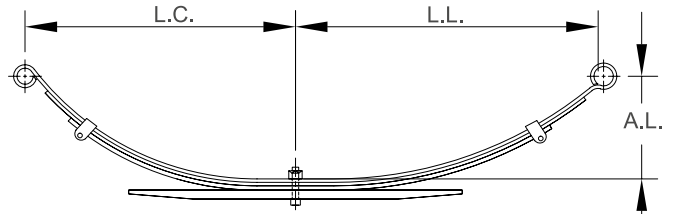

ANCHO	# HOJAS	CALIBRE	ARCO LIBRE	LONGITUD LADO CORTO	LONGITUD LADO LARGO	BUJE LADO CORTO	BUJE LADO LARGO	PUNTA LADO CORTO	PUNTA LADO LARGO
2 1/3	4 / 8.0,7.0,18.0	-	8	27 1/2	26	RB201-B	RB252-R	3	2

KA69-255

NISSAN

Muelle Trasera

- Aplicación: Frontier 3 Leaf Spring #Original: 550204S100
- Modelo: 98-04
- Capacidad: 1250 lb

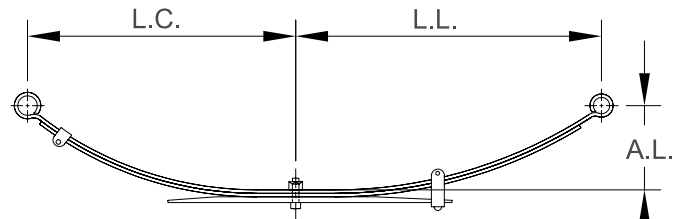

ANCHO	# HOJAS	CALIBRE	ARCO LIBRE	LONGITUD LADO CORTO	LONGITUD LADO LARGO	BUJE LADO CORTO	BUJE LADO LARGO	PUNTA LADO CORTO	PUNTA LADO LARGO
2 1/3	3 / .323 .588	-	6 1/2	22 1/4	25	RB252-B	RB201-B	2	2

KA69-251

NISSAN

Muelle Trasera

- Aplicación: Nissan Estaquitas F-4000 #Original: 55020F4000-01
- Modelo: 94 #Rassini: 80-180C

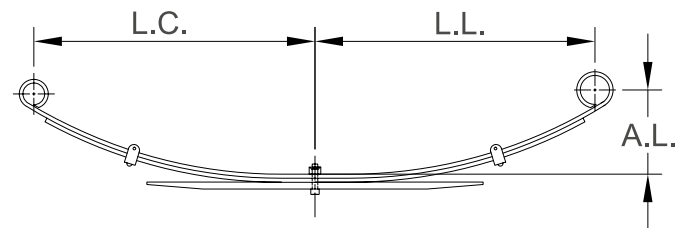

ANCHO	# HOJAS	CALIBRE	ARCO LIBRE	LONGITUD LADO CORTO	LONGITUD LADO LARGO	BUJE LADO CORTO	BUJE LADO LARGO	PUNTA LADO CORTO	PUNTA LADO LARGO
2 1/4	4 / .323	.323	4 1/2	23 5/8	23 5/8	-	RB201	1	1
	1A	-	5	23 5/8	23 5/8	-	RB201	1	1
	2A	-	5	21 3/4	21 3/4	-	-	13	13
	2R	-	5	23 5/8	23 5/8	-	-	5	5

KA69-111

NISSAN

Muelle Trasera

- Aplicación: Pick Up 1600 #Original: 55020-25211
- Modelo: 73-83 #Rassini: 80-180-A

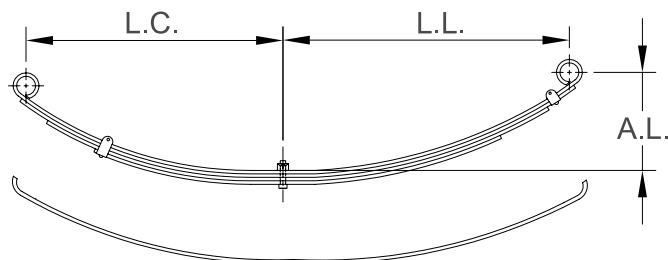

ANCHO	# HOJAS	CALIBRE	ARCO LIBRE	LONGITUD LADO CORTO	LONGITUD LADO LARGO	BUJE LADO CORTO	BUJE LADO LARGO	PUNTA LADO CORTO	PUNTA LADO LARGO
2 1/4	5 / .323	-	5 1/4	22 1/4	25	RB760A	RB762	 1	1 
	1A	-	5 1/4	22 1/4	25	RB760A	RB762	 1	1 
	2A	-	5 1/4	20 3/8	22 3/4	-	-	 21	21 
	2R	-	5 1/4	24 1/8	26 7/8	-	-	 5	5 





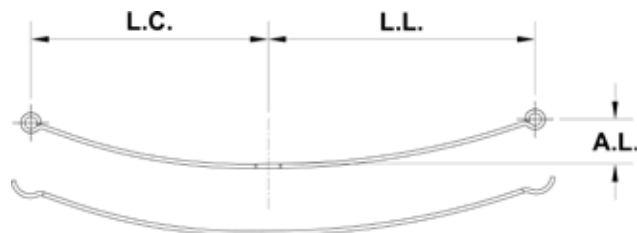

KA69-2017

NISSAN

Muelle

- Aplicación: Estaqueta NP300
- Modelo: 2017



ANCHO	# HOJAS	CALIBRE	ARCO LIBRE	LONGITUD LADO CORTO	LONGITUD LADO LARGO	BUJE LADO CORTO	BUJE LADO LARGO	PUNTA LADO CORTO	PUNTA LADO LARGO
.60	.9	-	4 7/8	26 1/4	23 13/16	1.55	1.238	 2	2 
	1A	-	4 7/8	26 1/4	23 13/16	-	-	 2	2 
	2A	-	4 7/8	26 1/4	23 4/5	-	-	 7A	7A 

KA69-1114

NISSAN

Muelle

- Aplicación: Urvan
- Modelo: 2014

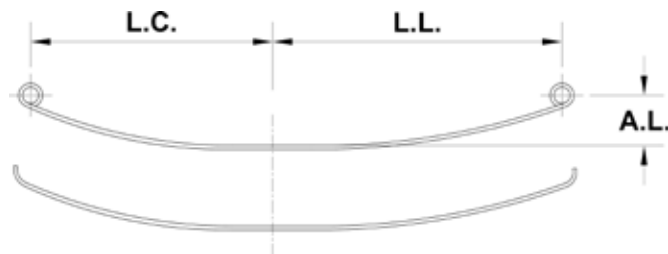

ANCHO	# HOJAS	CALIBRE	ARCO LIBRE	LONGITUD LADO CORTO	LONGITUD LADO LARGO	BUJE LADO CORTO	BUJE LADO LARGO	PUNTA LADO CORTO	PUNTA LADO LARGO
2.25	.323	.323	6.25	23	27 1/2	1.5	1.5	 1	1 
	1A	-	6.25	23	27 1/2	-	-	 1	1 
	2A	-	6.25	22 1/4	26	-	-	 10	10 
	2R	-	6.25	23	27 1/2	-	-	 5	5 

KA64-1001

MITSUBISHI

Muelle Trasera

- Aplicación: Pick Up L200

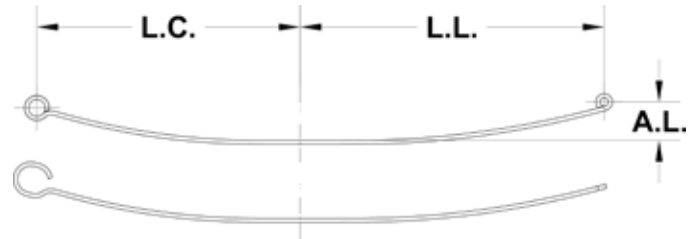

ANCHO	# HOJAS	CALIBRE	ARCO LIBRE	LONGITUD LADO CORTO	LONGITUD LADO LARGO	BUJE LADO CORTO	BUJE LADO LARGO	PUNTA LADO CORTO	PUNTA LADO LARGO
.60	9	-	5.5	21 5/8	30 5/8	1.5	1.125	2	1
	1A	-	5.5	21 5/8	30 5/8	-	-	2	1
	2R	-	5.5	21 5/8	30 5/8	-	-	7	10

KA23-510

OISA CONDOR

Muelle Delantera

- Aplicación: Detroit Steel Products #Original: 23510
- Modelo: 03

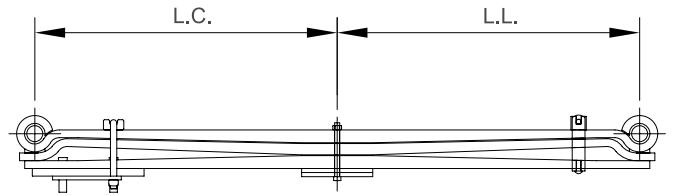

ANCHO	# HOJAS	CALIBRE	ARCO LIBRE	LONGITUD LADO CORTO	LONGITUD LADO LARGO	BUJE LADO CORTO	BUJE LADO LARGO	PUNTA LADO CORTO	PUNTA LADO LARGO
3	3 / 1.375	1.375	3 11/16	29 3/4	29 3/4	RB191	RB191	2	2
	1A	1.375	3 11/16	29 3/4	29 3/4	RB191	RB191	2	2
	2A	1.375	3 11/16	29 3/4	29 3/4	-	-	8	8
	3A	1.375	3 11/16	30 3/4	30 3/4	-	-	9	9

KA75-220

PETERBILT

Muelle Delantera

- Aplicación: 2 Leaf Taper Spring 6,570# #Original: 0202099
- Capacidad: 6570 lb

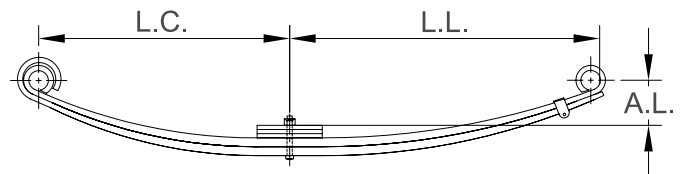

ANCHO	# HOJAS	CALIBRE	ARCO LIBRE	LONGITUD LADO CORTO	LONGITUD LADO LARGO	BUJE LADO CORTO	BUJE LADO LARGO	PUNTA LADO CORTO	PUNTA LADO LARGO
4	5 / .940, .499	-	5 3/8	26 3/4	25 5/8	RNK	RNK	1	1

KA75-212

PETERBILT

Muelle Delantera

- Aplicación: Peterbilt 2 Leaf Full Taper #Original: 0202177
- Capacidad: 5400 lb

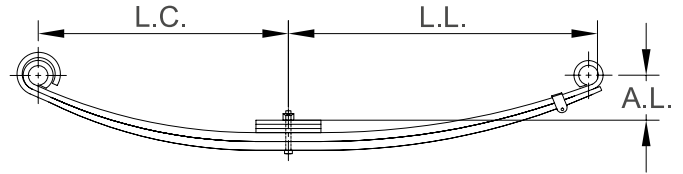

ANCHO	# HOJAS	CALIBRE	ARCO LIBRE	LONGITUD LADO CORTO	LONGITUD LADO LARGO	BUJE LADO CORTO	BUJE LADO LARGO	PUNTA LADO CORTO	PUNTA LADO LARGO
4	5 / .850, .401	-	5 1/2	26 3/4	25 5/8	RNK	RNK	1	1

KA75-210

PETERBILT

Muelle Delantera

- Aplicación: 2 Leaf Taper Spring 5,600 #Original: 0205845
- Capacidad: 5600 lb #Rassini: 75-210

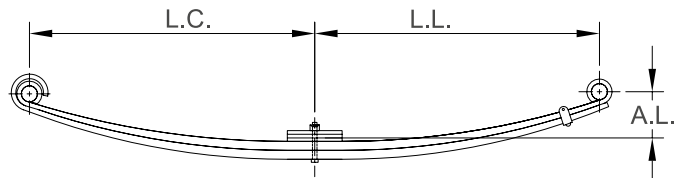

ANCHO	# HOJAS	CALIBRE	ARCO LIBRE	LONGITUD LADO CORTO	LONGITUD LADO LARGO	BUJE LADO CORTO	BUJE LADO LARGO	PUNTA LADO CORTO	PUNTA LADO LARGO
4	5 / .999, .401	-	6	32 1/8	32 1/8	RNK	RNK	1	1

KA75-178

PETERBILT

Muelle Delantera

- Aplicación: Peterbilt Spring 02-01817 #Original: 0201817
- Capacidad: 10500 lb

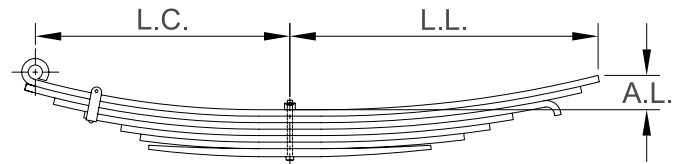

ANCHO	# HOJAS	CALIBRE	ARCO LIBRE	LONGITUD LADO CORTO	LONGITUD LADO LARGO	BUJE LADO CORTO	BUJE LADO LARGO	PUNTA LADO CORTO	PUNTA LADO LARGO
4	7 / .625	-	3 5/8	32	35 3/8	RNK	-	1	21

KA75-176

PETERBILT

Muelle Delantera

- Aplicación: Peterbilt Spring 8,200 #Original: 0201792
- Capacidad: 8200 lb

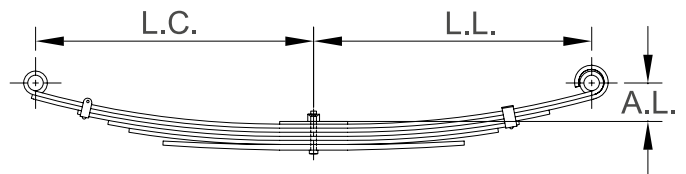

ANCHO	# HOJAS	CALIBRE	ARCO LIBRE	LONGITUD LADO CORTO	LONGITUD LADO LARGO	BUJE LADO CORTO	BUJE LADO LARGO	PUNTA LADO CORTO	PUNTA LADO LARGO
4	7 / .499, .360	.499	4 1/2	25 1/8	26 5/8	RNK	RNK	1	4
	1A	.499	4 1/2	25 1/8	26 5/8	-	-	1	1
	2A	.499	4 1/2	25 1/8	27 5/8	-	-	10	4

KA75-170

PETERBILT

Muelle Delantera

- Aplicación: Peterbilt Spring 9,200 #Original: 0201728
- Capacidad: 9200 lb

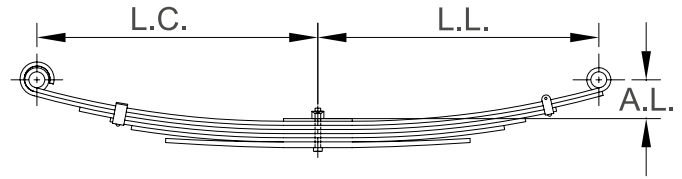

ANCHO	# HOJAS	CALIBRE	ARCO LIBRE	LONGITUD LADO CORTO	LONGITUD LADO LARGO	BUJE LADO CORTO	BUJE LADO LARGO	PUNTA LADO CORTO	PUNTA LADO LARGO
4	7 / .499, .360	.499	4 1/2	25 13/16	25 13/16	RNK	RNK	1	1
	1A	.499	4 1/2	25 13/16	25 13/16	-	-	1	1
	2A	.499	4 1/2	25 13/16	25 13/16	-	-	4	10

KA75-163

PETERBILT

Muelle Trasera

- Aplicación: Low Air Spring - 3 End Holes #Original: 0307640
- #Rassini: 75-163

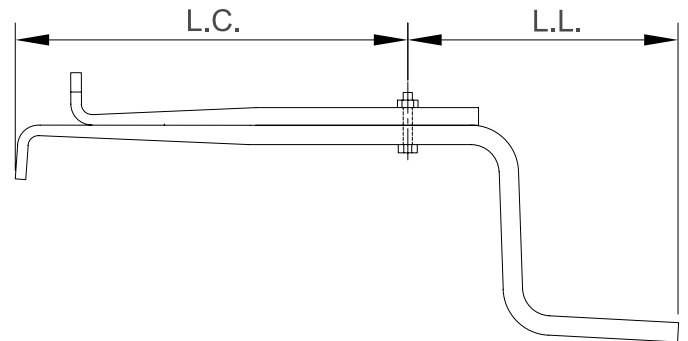

ANCHO	# HOJAS	CALIBRE	ARCO LIBRE	LONGITUD LADO CORTO	LONGITUD LADO LARGO	BUJE LADO CORTO	BUJE LADO LARGO	PUNTA LADO CORTO	PUNTA LADO LARGO
3 1/2	2 / 1.375, 1.250	1.250	ESPECIAL	23 5/8	5 1/16	-	-	17	17
	2A	1.375	ESPECIAL	27 21/32	19 1/4	-	-	17	17

KA75-160

PETERBILT

Muelle Delantera

- Aplicación: Peterbilt 3 Leaf Full Taper #Original: 0201799
- Capacidad: 8200 lb

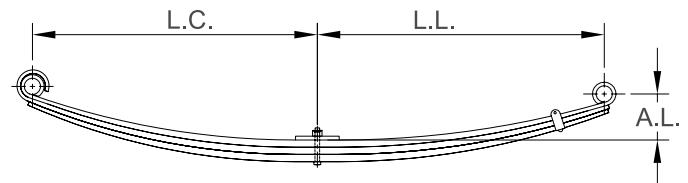

ANCHO	# HOJAS	CALIBRE	ARCO LIBRE	LONGITUD LADO CORTO	LONGITUD LADO LARGO	BUJE LADO CORTO	BUJE LADO LARGO	PUNTA LADO CORTO	PUNTA LADO LARGO
4	4 / .447, .788	-	5 1/4	26 3/4	25 1/2	RNK	RNK	1	4

KA75-132



PETERBILT

Muelle Delantera

- Aplicación: Use 75-130 In Pairs
- Capacidad: 5300 lb

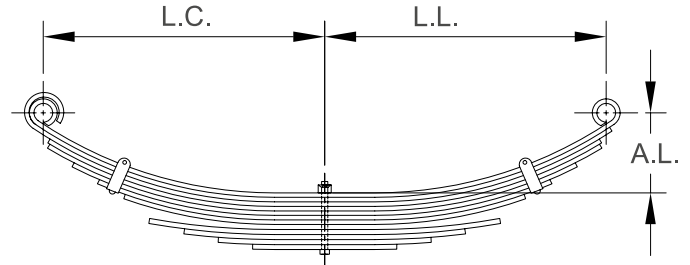
#Original:
A02490-
25920351S



ANCHO	# HOJAS	CALIBRE	ARCO LIBRE	LONGITUD LADO CORTO	LONGITUD LADO LARGO	BUJE LADO CORTO	BUJE LADO LARGO	PUNTA LADO CORTO	PUNTA LADO LARGO
3 1/2	11/.360, .323, .401	-	6 7/8	24	24	RNI	RNI	 1	1 
	1A	-	6 7/8	24	24	-	-	 1	1 
	2A	-	6 7/8	24	24	-	-	 4	10 

KA75-125

PETERBILT

Muelle Trasera

- Aplicación: Repuesto
- #Original: 0302432

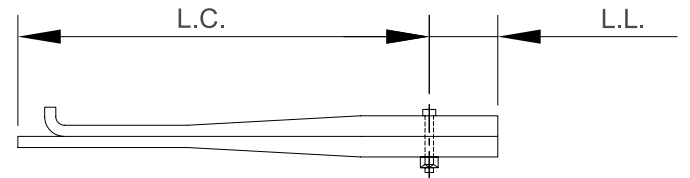

ANCHO	# HOJAS	CALIBRE	ARCO LIBRE	LONGITUD LADO CORTO	LONGITUD LADO LARGO	BUJE LADO CORTO	BUJE LADO LARGO	PUNTA LADO CORTO	PUNTA LADO LARGO
4	2 / 1.210	1.210	PLANAS	4 3/8	23 11/16	-	-	 18	21 
	1A	1.210	PLANAS	4 3/8	24 3/4	-	-	 18	21 
	2A	1.210	PLANAS	4 3/8	24 3/4	-	-	 21	21 

KA70-151









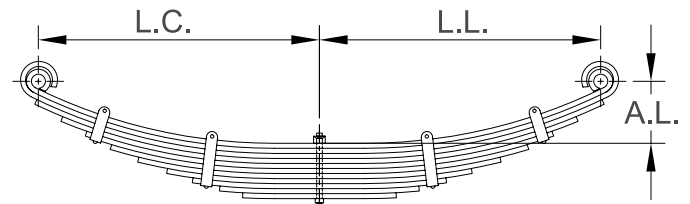



RAMÍREZ

Muelle Delantera

- Aplicación: Tractocamion R18, D-15, 20, 22
- Modelo: 65-83

#Original: 15811
#Rassini: 70-151



ANCHO	# HOJAS	CALIBRE	ARCO LIBRE	LONGITUD LADO CORTO	LONGITUD LADO LARGO	BUJE LADO CORTO	BUJE LADO LARGO	PUNTA LADO CORTO	PUNTA LADO LARGO
3 1/2	12 / .499 .447	.499	5 1/2	26	26	NJI	NJI	 1	1 
	1A	.499	5 1/2	26	26	NJI	NJI	 1	1 
	2A	.499	5 1/2	26	26	-	-	 4	4 
	3A	.447	5 1/2	26	26	-	-	 10	10 
	4A	.447	5 1/2	23 7/16	23 7/16	-	-	 10	10 
	5A	.447	5 1/2	21 1/8	21 1/8	-	-	 13	13 



KAAR-38906A

RASTRAS AGRÍCOLAS

Rastras Agrícolas

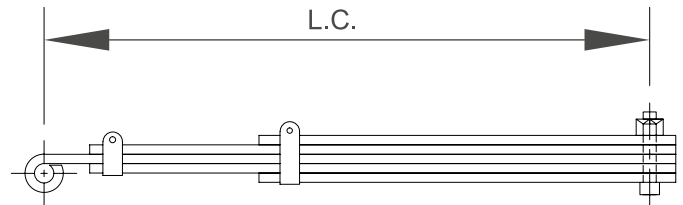
- Aplicación: Rastras John Deere



ANCHO	# HOJAS	CALIBRE	ARCO LIBRE	LONGITUD LADO CORTO	LONGITUD LADO LARGO	BUJE LADO CORTO	BUJE LADO LARGO	PUNTA LADO CORTO	PUNTA LADO LARGO
3	5 / .499	-	-	3/4	23 1/4	-	-	 3	21 
	1A	-	-	3/4	23 1/4	-	-	 3	21 
	2A	-	-	-	-	-	-	 13	13 
	3A	-	-	-	-	-	-	 13	13 

KAAR-38906

RASTRAS AGRÍCOLAS

Rastras Agrícolas

- Aplicación: Rastras John Deere #Rassini: 5336024

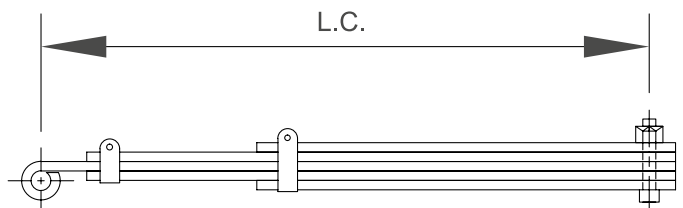

ANCHO	# HOJAS	CALIBRE	ARCO LIBRE	LONGITUD LADO CORTO	LONGITUD LADO LARGO	BUJE LADO CORTO	BUJE LADO LARGO	PUNTA LADO CORTO	PUNTA LADO LARGO
3	5 / .360	-	-	3/4	23 1/4	-	-	 3	21 
	1A	-	-	3/4	23 1/4	-	-	 3	21 
	2A	-	-	-	-	-	-	 13	13 
	3A	-	-	-	-	-	-	 13	13 

KAAR-36400

RASTRAS AGRÍCOLAS

Rastras Agrícolas

- Aplicación: Rastras John Deere #Rassini: 5336024

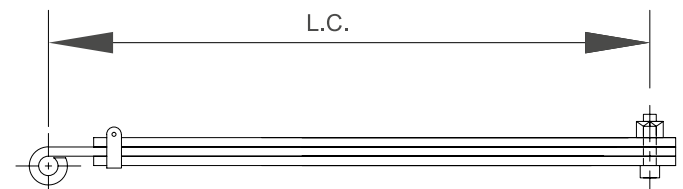

ANCHO	# HOJAS	CALIBRE	ARCO LIBRE	LONGITUD LADO CORTO	LONGITUD LADO LARGO	BUJE LADO CORTO	BUJE LADO LARGO	PUNTA LADO CORTO	PUNTA LADO LARGO
3	3 / .360	-	-	3/4	20 1/4	-	-	 3	21 
	1A	-	-	3/4	20 1/4	-	-	 3	21 

KA83-273

REYCO

Muelle Trasera

- Aplicación: Susp.T-450 Rabon, 4 Leaf Taper Spring 10,500
- Modelo: 00-04
- Capacidad: 10500 lb

#Original: HP482101500A
#Rassini: 71-158

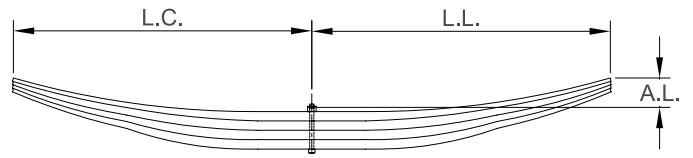

ANCHO	# HOJAS	CALIBRE	ARCO LIBRE	LONGITUD LADO CORTO	LONGITUD LADO LARGO	BUJE LADO CORTO	BUJE LADO LARGO	PUNTA LADO CORTO	PUNTA LADO LARGO
3	4 / .887	.887	5 1/4	29	29	-	-	21	21

KA83-257

REYCO

Muelle Trasera

- Aplicación: Reyco Kenwroth

#Original: 19967-01
#Rassini: 83-257

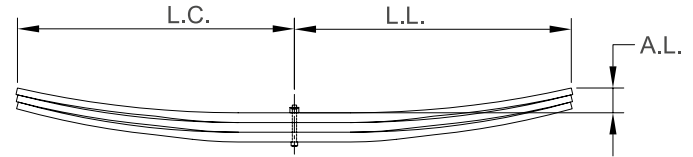

ANCHO	# HOJAS	CALIBRE	ARCO LIBRE	LONGITUD LADO CORTO	LONGITUD LADO LARGO	BUJE LADO CORTO	BUJE LADO LARGO	PUNTA LADO CORTO	PUNTA LADO LARGO
3	4 / .788	.788	5 1/2	29	29	PATÍN	PATÍN	16	16
	1A	.788	5 1/2	29	29	PATÍN	PATÍN	16	16

KA83-127

REYCO

Muelle Trasera

- Aplicación: Reyco 12 Leaf Spring
- Modelo: 98
- Capacidad: 9500 lb

#Original: 0988401

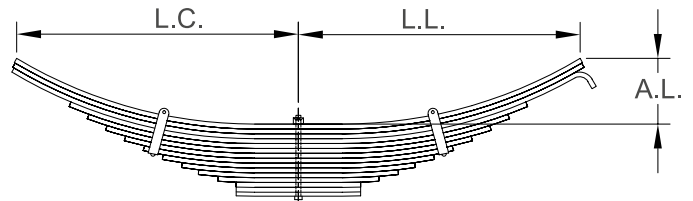

ANCHO	# HOJAS	CALIBRE	ARCO LIBRE	LONGITUD LADO CORTO	LONGITUD LADO LARGO	BUJE LADO CORTO	BUJE LADO LARGO	PUNTA LADO CORTO	PUNTA LADO LARGO
3	15 / .401	.401	4	22 7/8	22 7/8	-	-	10	10

KATRA-3384

REYCO

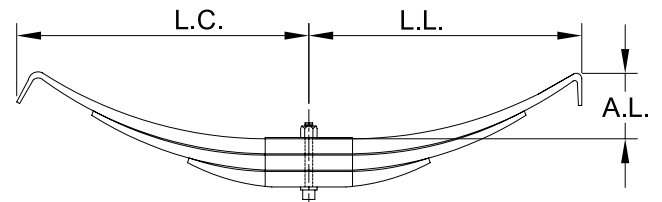

ANCHO	# HOJAS	CALIBRE	ARCO LIBRE	LONGITUD LADO CORTO	LONGITUD LADO LARGO	BUJE LADO CORTO	BUJE LADO LARGO	PUNTA LADO CORTO	PUNTA LADO LARGO
3	3/.938	.788	3 3/4	21 3/4	22	-	-	16	11

KA83-115

REYCO

Muelle Trasera

- Aplicación: Reyco 11 Leaf Spring #Original: 0947501
- Capacidad: 8500 lb

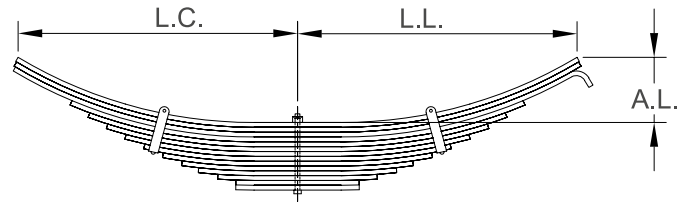

ANCHO	# HOJAS	CALIBRE	ARCO LIBRE	LONGITUD LADO CORTO	LONGITUD LADO LARGO	BUJE LADO CORTO	BUJE LADO LARGO	PUNTA LADO CORTO	PUNTA LADO LARGO
3	14 / .401	.401	4 1/2	23 1/8	23 1/8	-	-	 10	10 
	1A	.401	4 1/2	23 1/8	23 1/8	-	-	 10	10 
	2A	.401	4 1/2	23 1/8	23 1/8	-	-	 10	18 
	3A	.401	4 1/2	23 1/8	23 1/8	-	-	 10	10 
	4A	.401	4 1/2	17 3/8	17 3/8	-	-	 10	10 
	5A	.401	4 1/2	15 7/16	15 7/16	-	-	 10	10 
	6A	.401	4 1/2	13 1/2	13 1/2	-	-	 10	10 
	7A	.401	4 1/2	11 1/2	11 1/2	-	-	 13	13 
	8A	.401	4 1/2	9 7/8	9 7/8	-	-	 10	10 
	9A	.401	4 1/2	8 3/4	8 3/4	-	-	 10	10 
	10A	.401	4 1/2	7 1/8	7 1/8	-	-	 10	10 
	11A	.401	4 1/2	5 1/2	5 1/2	-	-	 10	10 





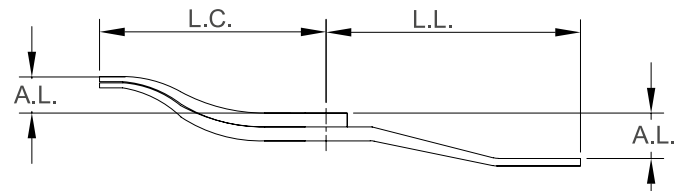

KATRA-3387

REYCO

Muelle Trasera

- Aplicación: Reyco #Original: 20741-01



ANCHO	# HOJAS	CALIBRE	ARCO LIBRE	LONGITUD LADO CORTO	LONGITUD LADO LARGO	BUJE LADO CORTO	BUJE LADO LARGO	PUNTA LADO CORTO	PUNTA LADO LARGO
3	2 / 1.375	-	-	-	-	-	-	 16	16 
	1A	-	3.62"	20 3/8	4 1/2	-	-	 16	16 
	2A	-	3.62"	20 3/8	27 3/8	-	-	 16	16 





KATRA-3372

REYCO

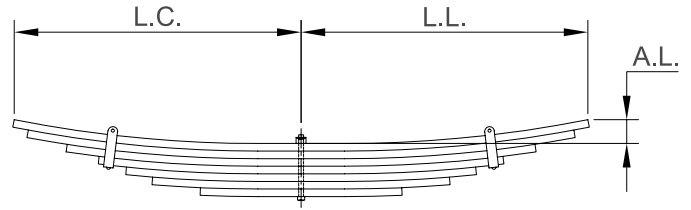
Muelle Trasera

- Aplicación: Caja Baja
- Modelo: 98



ANCHO	# HOJAS	CALIBRE	ARCO LIBRE	LONGITUD LADO CORTO	LONGITUD LADO LARGO	BUJE LADO CORTO	BUJE LADO LARGO	PUNTA LADO CORTO	PUNTA LADO LARGO
5	7	-	2 1/2	33	33	-	-	 21	21 
	1A	-	2 1/2	33	33	-	-	 21	21 





KATRA-3341

REYCO

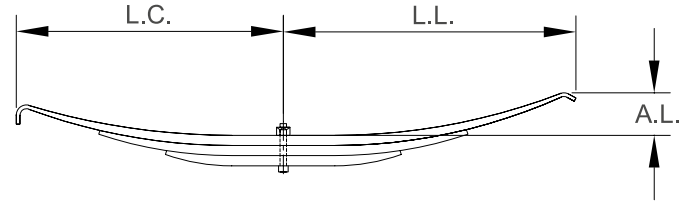
Muelle Trasera

- Aplicación: Reyco 0079-02 #Original: 0079-02
Low Arch
- Modelo: 86-88
- Capacidad: 8500 lb



ANCHO	# HOJAS	CALIBRE	ARCO LIBRE	LONGITUD LADO CORTO	LONGITUD LADO LARGO	BUJE LADO CORTO	BUJE LADO LARGO	PUNTA LADO CORTO	PUNTA LADO LARGO
3	3 / .788	-	3	21 3/8	23 3/16	-	-	 11	11 
	1A	-	-	21 3/8	23 3/16	-	-	 11	11 





KATRA-3340

REYCO

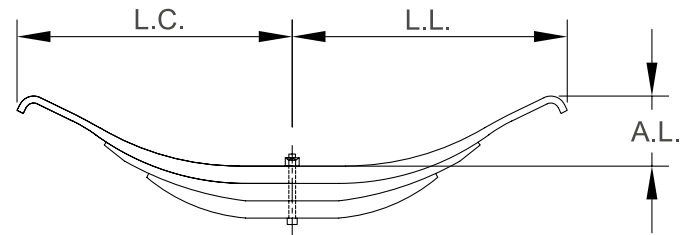
Muelle Trasera

- Aplicación: Reyco 0079-01 #Original: 0079-01
High Arch
- Modelo: 86-88
- Capacidad: 8500 lb



ANCHO	# HOJAS	CALIBRE	ARCO LIBRE	LONGITUD LADO CORTO	LONGITUD LADO LARGO	BUJE LADO CORTO	BUJE LADO LARGO	PUNTA LADO CORTO	PUNTA LADO LARGO
3	3 / .788	-	22 1/2	22 1/2	23 7/8	-	-	 11	11 
	1A	-	-	22 1/2	23 7/8	-	-	 11	11 

KATRA-3309

REYCO

Muelle Trasera

- Aplicación: Reyco 8 Leaf Spring #Original: 0178-01
- Capacidad: 11000 lb

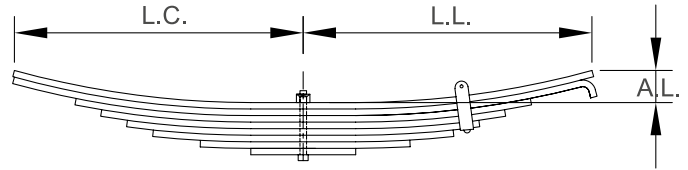

ANCHO	# HOJAS	CALIBRE	ARCO LIBRE	LONGITUD LADO CORTO	LONGITUD LADO LARGO	BUJE LADO CORTO	BUJE LADO LARGO	PUNTA LADO CORTO	PUNTA LADO LARGO
3	8 / .499	-	4 1/2	21 1/2	22 7/8	-	-	10	10

KATRA-2297

REYCO

Muelle Trasera

- Aplicación: Reyco 9 Leaf Spring T7452
- Capacidad: 13000 lb

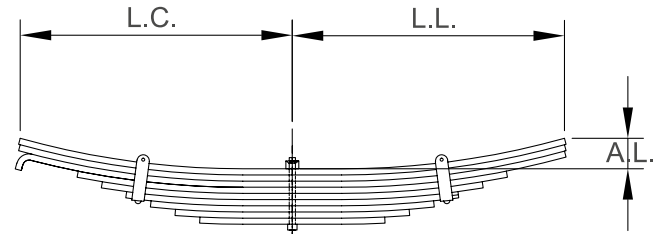

ANCHO	# HOJAS	CALIBRE	ARCO LIBRE	LONGITUD LADO CORTO	LONGITUD LADO LARGO	BUJE LADO CORTO	BUJE LADO LARGO	PUNTA LADO CORTO	PUNTA LADO LARGO
3	9 / .499	.499	2 5/8	21 1/2	21 1/2	-	-	10	10
	1A	.499	2 5/8	21 1/2	21 1/2	-	-	10	10
	2A	.499	2 5/8	21 1/2	21 3/4	-	-	10	18
	3A	.499	2 5/8	16 1/2	16 1/2	-	-	10	10
	4A	.499	2 5/8	14 1/2	14 1/2	-	-	10	10
	5A	.499	2 5/8	12 1/2	12 1/2	-	-	13	13
	6A	.499	2 5/8	10 1/2	10 1/2	-	-	21	21
	7A	.499	2 5/8	8 1/2	8 1/2	-	-	21	21
	8A	.499	2 5/8	6 1/2	6 1/2	-	-	21	21

KATRA-2270

REYCO

Muelle Trasera

- Aplicación: Reyco 8 Leaf Spring T3564
 - Capacidad: 11000 lb
- #Original: T3564

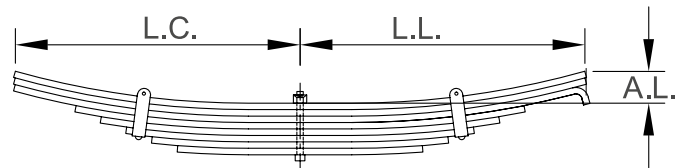

ANCHO	# HOJAS	CALIBRE	ARCO LIBRE	LONGITUD LADO CORTO	LONGITUD LADO LARGO	BUJE LADO CORTO	BUJE LADO LARGO	PUNTA LADO CORTO	PUNTA LADO LARGO
3	8 / .499	.499	3 5/8	21 11/16	21 11/16	-	-	10	10
	1A	.499	3 5/8	21 11/16	21 11/16	-	-	10	10
	2A	.499	3 5/8	21 11/16	21 11/16	-	-	10	18
	3A	.499	3 5/8	16 1/2	16 1/2	-	-	10	10
	4A	.499	3 5/8	13 1/2	13 1/2	-	-	21	21
	5A	.499	3 5/8	11 1/2	11 1/2	-	-	13	13
	6A	.499	3 5/8	9	9	-	-	21	21
	7A	.499	3 5/8	6 1/2	6 1/2	-	-	21	21



KATRA-2256

REYCO

Muelle Trasera

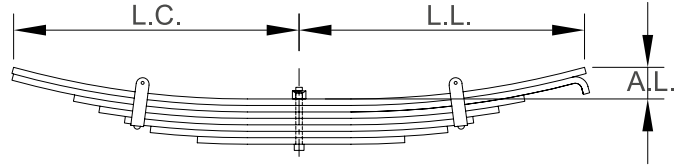
- Aplicación: Reyco 7 Leaf Spring #Original: T3086
- Capacidad: 9000 lb



ANCHO	# HOJAS	CALIBRE	ARCO LIBRE	LONGITUD LADO CORTO	LONGITUD LADO LARGO	BUJE LADO CORTO	BUJE LADO LARGO	PUNTA LADO CORTO	PUNTA LADO LARGO
3	7 / .499	.499	4 1/4	21 7/8	21 7/8	-	-	 10	10 

KATRA-075

REYCO

Muelle Trasera

- Aplicación: Reyco Spring Beam #Original: 19914-01
- 86AR R/H
- Capacidad: 19000 lb

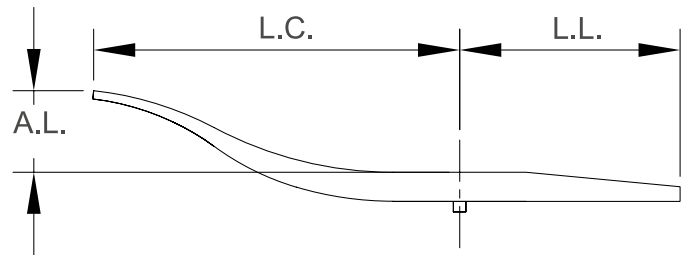

ANCHO	# HOJAS	CALIBRE	ARCO LIBRE	LONGITUD LADO CORTO	LONGITUD LADO LARGO	BUJE LADO CORTO	BUJE LADO LARGO	PUNTA LADO CORTO	PUNTA LADO LARGO
3	1 / 1.750	1.750	4 7/8	22 3/4	13 1/4	-	-	 17	16 



KATRA-074

REYCO

Muelle Trasera

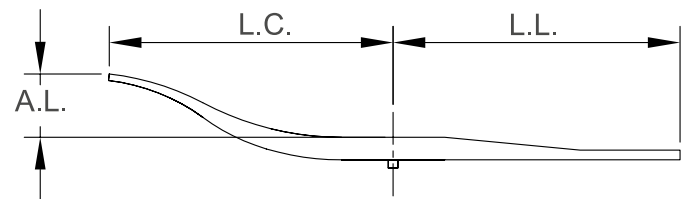
- Aplicación: Reyco Spring Beam #Original: 19913-01
- 86ar L/H
- Capacidad: 19000 lb



ANCHO	# HOJAS	CALIBRE	ARCO LIBRE	LONGITUD LADO CORTO	LONGITUD LADO LARGO	BUJE LADO CORTO	BUJE LADO LARGO	PUNTA LADO CORTO	PUNTA LADO LARGO
3	1 / 1.750	1.750	4 7/8	22	22 1/4	-	-	 13	16 



KATRA-038

REYCO

Muelle Trasera

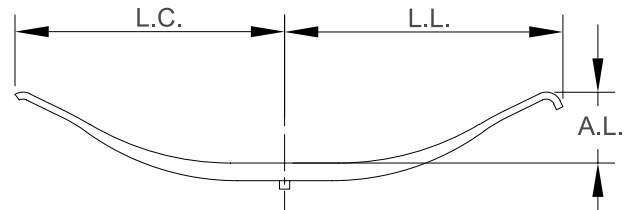
- Aplicación: Reyco Mono Leaf #Original: 15636-01
- 15636-01
- Capacidad: 12500 lb



ANCHO	# HOJAS	CALIBRE	ARCO LIBRE	LONGITUD LADO CORTO	LONGITUD LADO LARGO	BUJE LADO CORTO	BUJE LADO LARGO	PUNTA LADO CORTO	PUNTA LADO LARGO
3	1 / 1.625	1.625	4 1/2	21 5/8	22 3/8	-	-	 11	11 

KATRA-031

REYCO

Muelle Trasera

- Aplicación: Reyco Single Leaf #Original: T5555 T5555
- Capacidad: 11000 lb

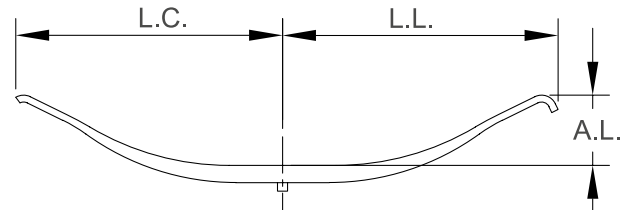

ANCHO	# HOJAS	CALIBRE	ARCO LIBRE	LONGITUD LADO CORTO	LONGITUD LADO LARGO	BUJE LADO CORTO	BUJE LADO LARGO	PUNTA LADO CORTO	PUNTA LADO LARGO
3	1 / 1.375	1.375	37/8	21 3/4	21 7/8	-	-	11	11

KA71-198A-13H

TANDEM

Muelle Trasera

- Aplicación: Eje Tandem #Original: T1103499
- Modelo: 78-83 #Rassini: 71-198-A

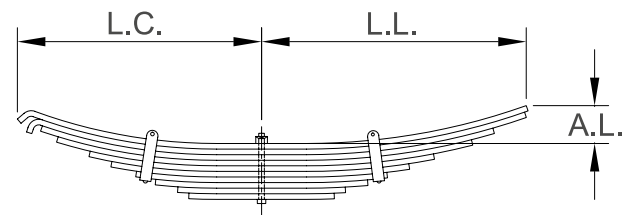



ANCHO	# HOJAS	CALIBRE	ARCO LIBRE	LONGITUD LADO CORTO	LONGITUD LADO LARGO	BUJE LADO CORTO	BUJE LADO LARGO	PUNTA LADO CORTO	PUNTA LADO LARGO
3	10 / .360, .401, .447, .499	.499	3 3/8	22	23	-	-	21	21
	1A	.499	3	22	23	-	-	21	21
	2A	.499	3	22	23	-	-	18	21
	3A	.499	3	19	21	-	-	21	21
	4A	.499	3	17 1/2	19	-	-	21	21
	4R	.499	3	16 1/2	17	-	-	21	21
	5A	.499	3	15 1/2	15 1/2	-	-	21	21
	6A	.499	3	13 1/4	13 1/4	-	-	21	21
	7A	.499	3	11 1/4	11 1/4	-	-	21	21
	8A	.499	3	9 1/2	9 1/2	-	-	13	13
	9A	.499	3	7 1/2	7 1/2	-	-	21	21
	10A	.499	3	6 1/2	6 1/2	-	-	21	21
	11A	.499	3	5	5	-	-	21	21
	12A	.499	3	4	4	-	-	21	21
	13A	.499	3	3	3	-	-	21	21

KA71-191B-P TANDEM

Muelle Trasera

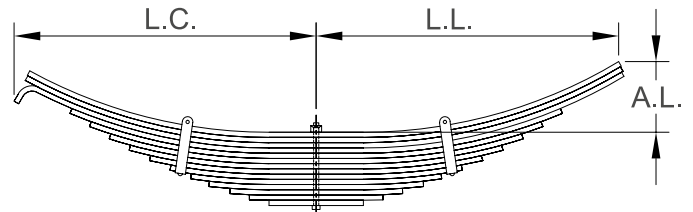
- Aplicación: 3 Ejes Tandem Tanque
- Modelo: 78-94
- #Original: C514344747
- #Rassini: 71-191-B







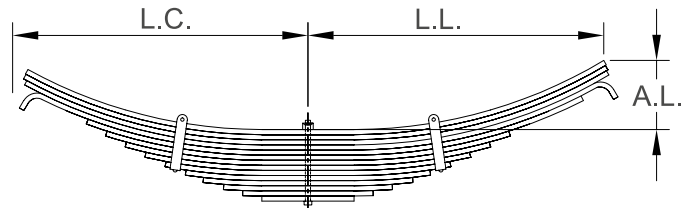

ANCHO	# HOJAS	CALIBRE	ARCO LIBRE	LONGITUD LADO CORTO	LONGITUD LADO LARGO	BUJE LADO CORTO	BUJE LADO LARGO	PUNTA LADO CORTO	PUNTA LADO LARGO
3	14 / .499	.499	4 1/2	22	26	-	-	 21	21 
	1A	.499	4 1/2	22	26	-	-	 21	21 
	2A	.499	4 1/2	22	27 1/4	-	-	 18	18 

KA71-191A TANDEM

Muelle Trasera

- Aplicación: Tandem 3 Ejes
- Modelo: 78-94
- #Original: CS14344745
- #Rassini: 71-191-A







ANCHO	# HOJAS	CALIBRE	ARCO LIBRE	LONGITUD LADO CORTO	LONGITUD LADO LARGO	BUJE LADO CORTO	BUJE LADO LARGO	PUNTA LADO CORTO	PUNTA LADO LARGO
3	14 / .499	.499	3 3/4	22 3/4	22 3/4	-	-	 21	21 
	1A	.499	3 3/4	22 3/4	22 3/4	-	-	 21	21 
	2A	.499	3 3/4	22 3/4	22 3/4	-	-	 18	21 

KA71-191 TANDEM

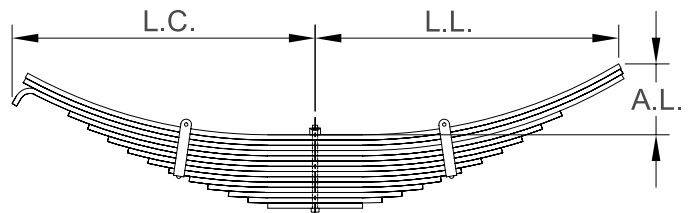
Muelle Trasera

- Aplicación: Eje Tandem Tanque
- Modelo: 78-94
- #Original: CS14344744
- #Rassini: 71-191



ANCHO	# HOJAS	CALIBRE	ARCO LIBRE	LONGITUD LADO CORTO	LONGITUD LADO LARGO	BUJE LADO CORTO	BUJE LADO LARGO	PUNTA LADO CORTO	PUNTA LADO LARGO
3	14 / .447	.447	3 3/8	21 3/4	23	-	-	 21	21 
	1A	.447	3 3/8	21 3/4	23	-	-	 21	21 

KA71-175-P

TANDEM

Muelle Trasera

- Aplicación: Eje Tandem #Original: MCM-II
- Modelo: 77-83 #Rassini: 71-175

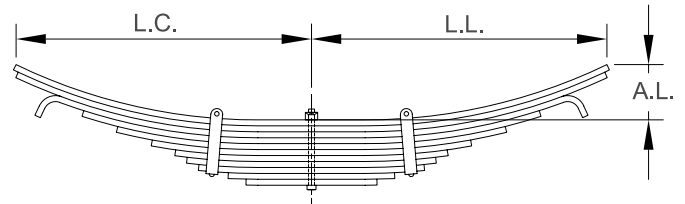

ANCHO	# HOJAS	CALIBRE	ARCO LIBRE	LONGITUD LADO CORTO	LONGITUD LADO LARGO	BUJE LADO CORTO	BUJE LADO LARGO	PUNTA LADO CORTO	PUNTA LADO LARGO
3	11 / .499	.499	4 1/2	22	28	-	-	21	21
	1A	.499	4 1/2	22	28	-	-	21	21

KA71-175A

TANDEM

Muelle Trasera

- Aplicación: Tandem 22 X 28 #Rassini: 71-175-A
- Sin Patin
- Modelo: 77-83

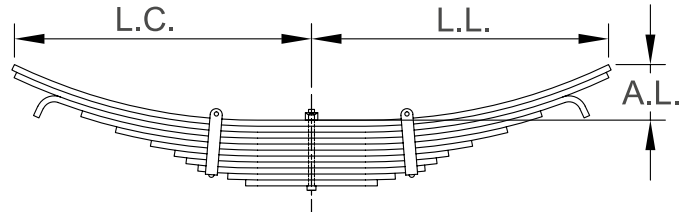

ANCHO	# HOJAS	CALIBRE	ARCO LIBRE	LONGITUD LADO CORTO	LONGITUD LADO LARGO	BUJE LADO CORTO	BUJE LADO LARGO	PUNTA LADO CORTO	PUNTA LADO LARGO
3	11 / .499	.499	4 3/4	22	28	-	-	21	21
	1A	.499	4 3/4	-	-	-	-	21	21

KA90-299

TOYOTA

Muelle Trasera

- Aplicación: Tacoma 3 Leaf Spring Lhs
- Modelo: 2005

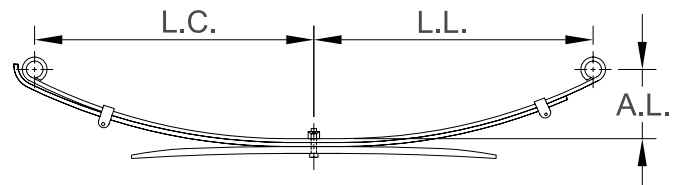

ANCHO	# HOJAS	CALIBRE	ARCO LIBRE	LONGITUD LADO CORTO	LONGITUD LADO LARGO	BUJE LADO CORTO	BUJE LADO LARGO	PUNTA LADO CORTO	PUNTA LADO LARGO
2 1/3	3 / 9.0,16.0	-	6 3/4	27 1/2	27 1/2	RB192	RB260	1	1

KA90-203

TOYOTA

Muelle Trasera

- Aplicación: Tacoma Left Side X-Cab #Original: 4822004070
- Modelo: 98-04
- Capacidad: 1100 lb

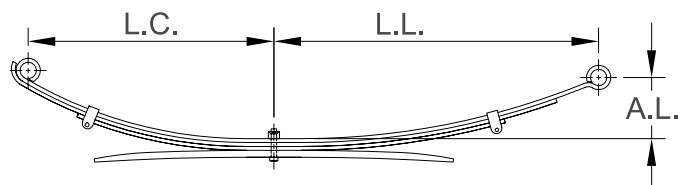

ANCHO	# HOJAS	CALIBRE	ARCO LIBRE	LONGITUD LADO CORTO	LONGITUD LADO LARGO	BUJE LADO CORTO	BUJE LADO LARGO	PUNTA LADO CORTO	PUNTA LADO LARGO
2 1/3	4 / 7.0	-	6 3/4	24 1/8	31 1/8	RB192	RB192-B	1	2

KA90-201
TOYOTA
Muelle Trasera

- Aplicación: Tacoma Right Side Xcab
- Modelo: 98-04
- Capacidad: 1100 lb

#Original:
4821004180A

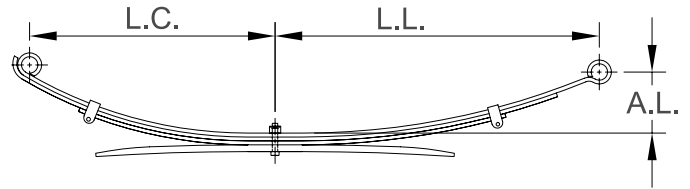

ANCHO	# HOJAS	CALIBRE	ARCO LIBRE	LONGITUD LADO CORTO	LONGITUD LADO LARGO	BUJE LADO CORTO	BUJE LADO LARGO	PUNTA LADO CORTO	PUNTA LADO LARGO
2 1/3	4 / 7.0	-	5 5/8	24 1/8	31 1/8	RB192	RB192-B	 1	2 

KA90-173
TOYOTA
Muelle Trasera

- Aplicación: Toyota Extended Cab Lhs
- Modelo: 95-97

#Original:
4822004030

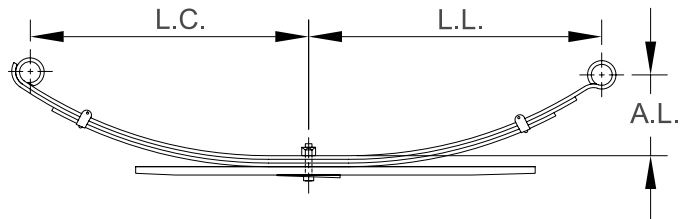

ANCHO	# HOJAS	CALIBRE	ARCO LIBRE	LONGITUD LADO CORTO	LONGITUD LADO LARGO	BUJE LADO CORTO	BUJE LADO LARGO	PUNTA LADO CORTO	PUNTA LADO LARGO
2 1/3	4 / 7.0	-	5 1/2	22 1/2	28 5/8	RB192	RB192-B	 1	2 

KA90-171
TOYOTA
Muelle Trasera

- Aplicación: Tacoma Extended Cab RhS
- Modelo: 95-97

#Original:
4821004080

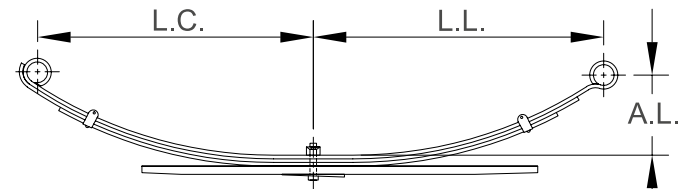



ANCHO	# HOJAS	CALIBRE	ARCO LIBRE	LONGITUD LADO CORTO	LONGITUD LADO LARGO	BUJE LADO CORTO	BUJE LADO LARGO	PUNTA LADO CORTO	PUNTA LADO LARGO
2 1/3	4 / 7.0	-	4 7/8	22 1/2	28 5/8	RB192	RB192-B	 1	2 

KA90-153A
TOYOTA
Muelle Trasera

- Aplicación: Cinto Trasero
- Modelo: 2006

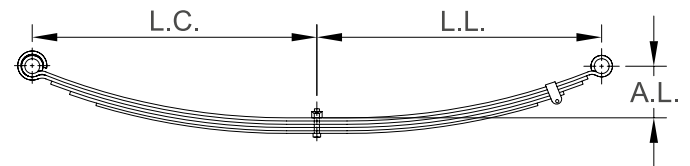
#Rassini: TO-5150



ANCHO	# HOJAS	CALIBRE	ARCO LIBRE	LONGITUD LADO CORTO	LONGITUD LADO LARGO	BUJE LADO CORTO	BUJE LADO LARGO	PUNTA LADO CORTO	PUNTA LADO LARGO
2 1/4	5 / .323	-	5 1/8	24	27 1/2	-	-	 2	2 
	1A	-	5 1/8	24	27 1/2	-	-	 2	2 

KA90-1491

TOYOTA

Muelle

- Aplicación: Hilux Americano Pick Up

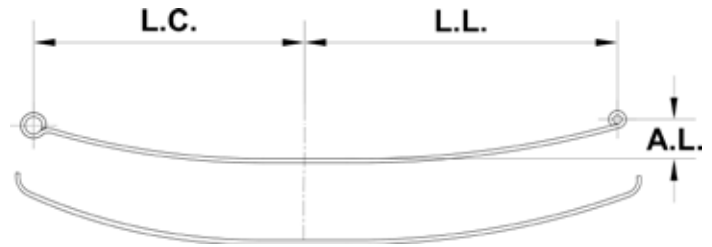

ANCHO	# HOJAS	CALIBRE	ARCO LIBRE	LONGITUD LADO CORTO	LONGITUD LADO LARGO	BUJE LADO CORTO	BUJE LADO LARGO	PUNTA LADO CORTO	PUNTA LADO LARGO
2.25	.323	-	5	22 3/8	28 7/8	1.562	1.187	1	1
	1A	-	5	22 3/8	28 7/8	-	-	1	1
	2R	-	5	22 3/8	28 7/8	-	-	5	5

KA90-1371

TOYOTA

Muelle

- Aplicación: Hilux Americano Pick Up

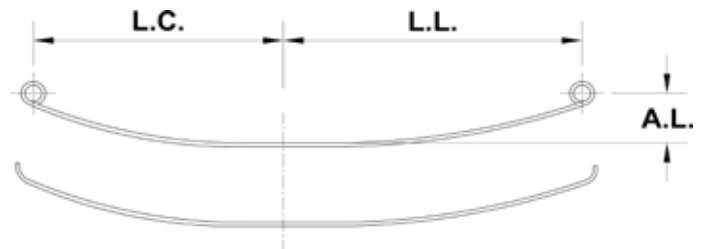

ANCHO	# HOJAS	CALIBRE	ARCO LIBRE	LONGITUD LADO CORTO	LONGITUD LADO LARGO	BUJE LADO CORTO	BUJE LADO LARGO	PUNTA LADO CORTO	PUNTA LADO LARGO
2.25	.323	-	7	20 1/4	20 1/4	1.125	1.125	21	21
	1A	-	7	20 1/4	20 1/4	-	-	21	21
	2R	-	7	20 1/4	20 1/4	-	-	5	5

KA90-1171

TOYOTA

Muelle

- Aplicación: Hilux Americano Pick Up
- Modelo: 1995-1996

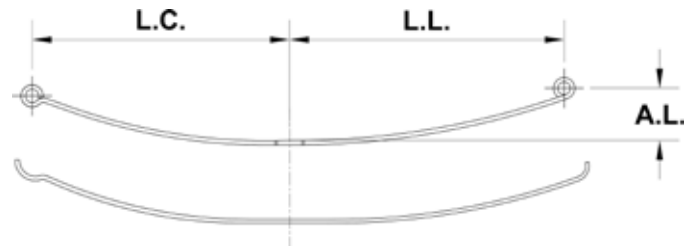

ANCHO	# HOJAS	CALIBRE	ARCO LIBRE	LONGITUD LADO CORTO	LONGITUD LADO LARGO	BUJE LADO CORTO	BUJE LADO LARGO	PUNTA LADO CORTO	PUNTA LADO LARGO
2.25	.323	-	7.25	22	29	1.625	1.125	2	1
	1A	-	7.25	22	29	-	-	2	1
	2R	-	7.25	22	29	-	-	7A	5

KA90-159

TOYOTA

Muelle

- Aplicación: Hilux T100

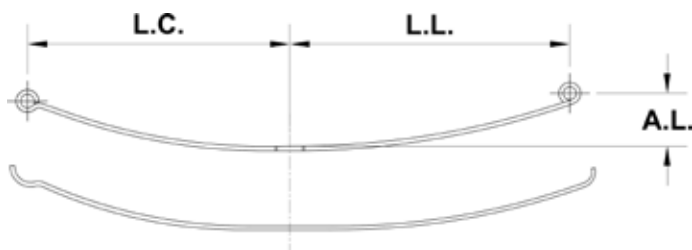

ANCHO	# HOJAS	CALIBRE	ARCO LIBRE	LONGITUD LADO CORTO	LONGITUD LADO LARGO	BUJE LADO CORTO	BUJE LADO LARGO	PUNTA LADO CORTO	PUNTA LADO LARGO
2.5	.401	-	7.25	23 1/2	31 1/2	1.375	1.187	 2	1 
	1A	-	7.25	23 1/2	31 1/2	-	-	 2	1 
	2R	-	7.25	23 1/2	31 1/2	-	-	 7A	5 

KA90-2009

TOYOTA

Muelle

- Aplicación: Hiace Panel
- Modelo: 2008-2009

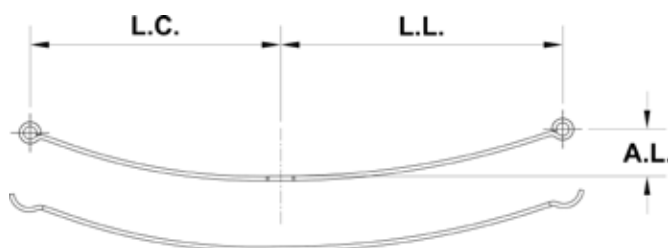

ANCHO	# HOJAS	CALIBRE	ARCO LIBRE	LONGITUD LADO CORTO	LONGITUD LADO LARGO	BUJE LADO CORTO	BUJE LADO LARGO	PUNTA LADO CORTO	PUNTA LADO LARGO
2.25	.401	-	4.5	20 3/4	26 1/4	19/16	19/16	 2	1 
	1A	-	4.5	20 3/4	26 1/4	-	-	 2	1 
	2R	-	4.5	20 3/4	26 1/4	-	-	 7A	7A 



KA90-297

TOYOTA

Muelle

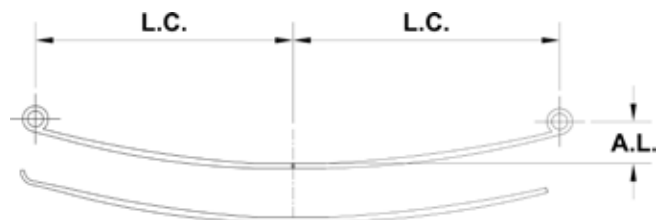
- Aplicación: Tacoma



ANCHO	# HOJAS	CALIBRE	ARCO LIBRE	LONGITUD LADO CORTO	LONGITUD LADO LARGO	BUJE LADO CORTO	BUJE LADO LARGO	PUNTA LADO CORTO	PUNTA LADO LARGO
.60	9	-	6.5	27 11/16	27 11/16	1.58	1.58	 1	1 
	1A	-	6.5	27 11/16	27 11/16	-	-	 1	1 
	2R	-	6.5	27 11/16	25 11/18	-	-	 5	10 

KA71-204-P

TRAILMOBILE

Muelle Delantera

- Aplicación: Eje Tandem
- Modelo: 78-83

#Original: M3P3-2
#Rassini: 71-204

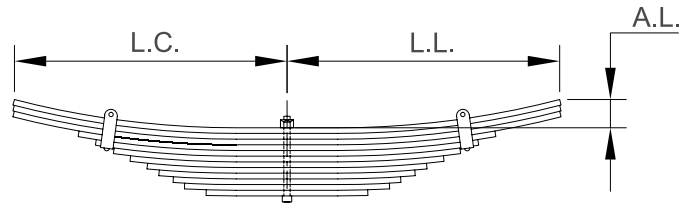

ANCHO	# HOJAS	CALIBRE	ARCO LIBRE	LONGITUD LADO CORTO	LONGITUD LADO LARGO	BUJE LADO CORTO	BUJE LADO LARGO	PUNTA LADO CORTO	PUNTA LADO LARGO
3 1/2	12 / .499 .447	.499	2 1/2	21 13/16	21 13/16	-	-	10	10
	1A	.447	2 1/2	21 13/16	21 13/16	-	-	10	10
	2A	.447	2 1/2	16 1/2	16 1/2	-	-	10	10
	3A	.447	2 1/2	15 1/8	15 1/8	-	-	10	10
	4A	.447	2 1/2	13 11/16	13 11/16	-	-	10	10
	5A	.447	2 1/2	12 3/8	12 3/8	-	-	10	10
	6A	.447	2 1/2	10 15/16	10 15/16	-	-	13	13
	7A	.447	2 1/2	9	9	-	-	10	10
	8A	.447	2 1/2	8 1/8	8 1/8	-	-	10	10

KATRA-1492

TRAILMOBILE

Muelle Trasera

- Aplicación: Trailmobile 3 Leaf Spring
- Capacidad: 9500 lb

#Original: 3-A3-62

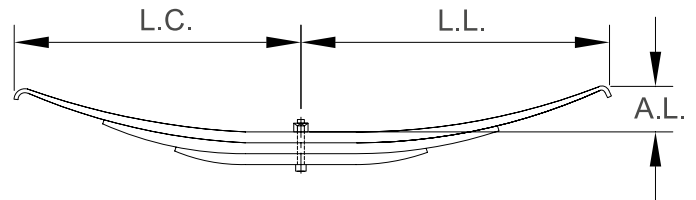

ANCHO	# HOJAS	CALIBRE	ARCO LIBRE	LONGITUD LADO CORTO	LONGITUD LADO LARGO	BUJE LADO CORTO	BUJE LADO LARGO	PUNTA LADO CORTO	PUNTA LADO LARGO
3 1/2	3 / .788	.788	4 3/16	20 11/16	20 11/16	-	-	11	11
	1A	.788	4 3/16	20 11/16	20 11/16	-	-	11	11
	2A	.788	4 3/16	13	13	-	-	15	15
	3A	.788	4 3/16	8 1/4	8 1/4	-	-	15	15

KATRA-051

TRAILMOBILE

Muelle Trasera

- Aplicación: Trailmobile

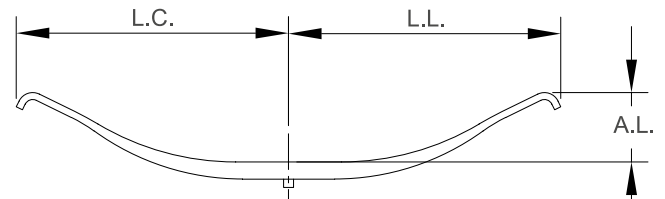

ANCHO	# HOJAS	CALIBRE	ARCO LIBRE	LONGITUD LADO CORTO	LONGITUD LADO LARGO	BUJE LADO CORTO	BUJE LADO LARGO	PUNTA LADO CORTO	PUNTA LADO LARGO
3 1/2	1 / 1.5	1.5	5 1/4	21 3/8	21 3/8	-	-	11	11
	1A	-	5 1/4	21 3/8	21 3/8	-	-	11	11

KA90-210





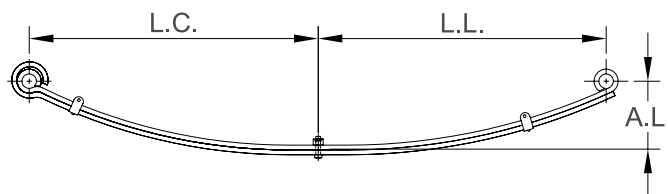

VOLKSWAGEN

Muelle Delantera

- Aplicación: Autobus Volkswagen
- Modelo: 05-07

#Original: 2R0411101-C
#Rassini: 90-211



ANCHO	# HOJAS	CALIBRE	ARCO LIBRE	LONGITUD LADO CORTO	LONGITUD LADO LARGO	BUJE LADO CORTO	BUJE LADO LARGO	PUNTA LADO CORTO	PUNTA LADO LARGO
3	3 / .499	.499	6 5/8	34	34	-	-	 2	1 
	1A	.499	6 5/8	34	34	-	-	 2	1 
	2A	.499	6 5/8	34	35	-	-	 4	16 

KA90-200





VOLKSWAGEN

Muelle Delantera

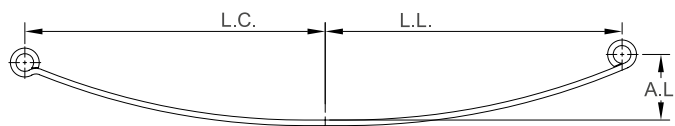
- Aplicación: Minibus Volkswagen

#Original: 2R2411101
#Rassini: 90-200



ANCHO	# HOJAS	CALIBRE	ARCO LIBRE	LONGITUD LADO CORTO	LONGITUD LADO LARGO	BUJE LADO CORTO	BUJE LADO LARGO	PUNTA LADO CORTO	PUNTA LADO LARGO
3	1 / .788	.788	8 1/8	34	34	1 13/16	1 13/16	 2	1 
	1A	.788	8 1/8	34	34	1 13/16	1 13/16	 2	1 









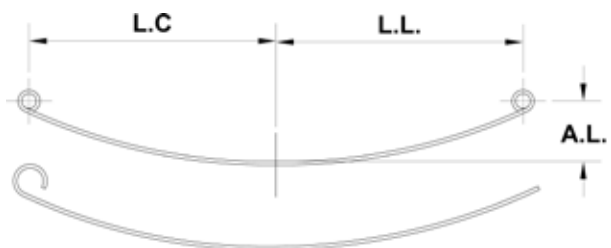



KA99-310

VOLKSWAGEN

Muelle Delantera

- Aplicación: 17-210 EOD
- Modelo: 2005



ANCHO	# HOJAS	CALIBRE	ARCO LIBRE	LONGITUD LADO CORTO	LONGITUD LADO LARGO	BUJE LADO CORTO	BUJE LADO LARGO	PUNTA LADO CORTO	PUNTA LADO LARGO
4	.499	-	-	35 1/2	35 1/2	-	-	 1	1 
	1A	-	-	35 1/2	35 1/2	-	-	 1	1 
	2A	-	-	35 1/2	36	-	-	 4	9 
	3A	-	-	34	34	-	-	 10	10 
	4A	-	-	31	31	-	-	 10	10 
	5A	-	-	29	29	-	-	 10	10 





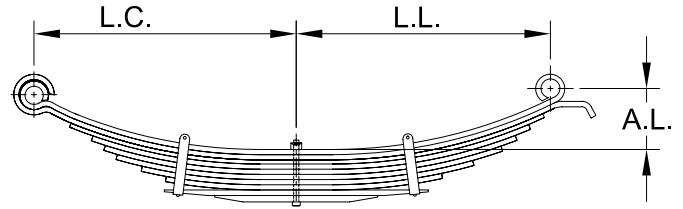

KA33-028

VOLKSWAGEN

Muelle Trasera

- Aplicación: Minibus Volkswagen #Original: 2P0511131
- Modelo: 05-07 #Rassini: 91-120



ANCHO	# HOJAS	CALIBRE	ARCO LIBRE	LONGITUD LADO CORTO	LONGITUD LADO LARGO	BUJE LADO CORTO	BUJE LADO LARGO	PUNTA LADO CORTO	PUNTA LADO LARGO
3	2 / .401	.401	6 7/8	28	28	2 1/4	2 1/4	 2	1 
	1A	.401	6 7/8	28	28	2 1/4	2 1/4	 2	1 
	2A	.401	6 7/8	28	37	-	-	 7	18 





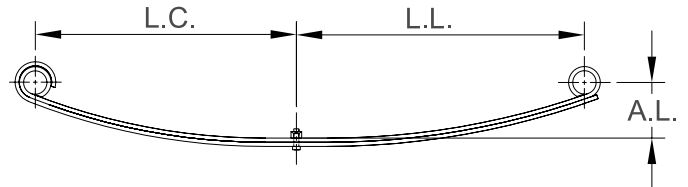

KA96-1308

VOLVO

Muelle Delantera

- Aplicación: 2 Leaf Taper Tb78 Bushings
- Modelo: 1997
- Capacidad: 6059 lb
- #Original: 257810



ANCHO	# HOJAS	CALIBRE	ARCO LIBRE	LONGITUD LADO CORTO	LONGITUD LADO LARGO	BUJE LADO CORTO	BUJE LADO LARGO	PUNTA LADO CORTO	PUNTA LADO LARGO
4	2 / 1"	1	4 3/4	27 5/8	31 1/4	TB26	TB26	 1	1 
	1A	.999	1 1/2	27 1/2	31	TB26	TB26	 1	1 
	2A	.999	1 1/2	27 1/2	31	-	-	 4	9 



KA96-1219

VOLVO

Muelle Trasera

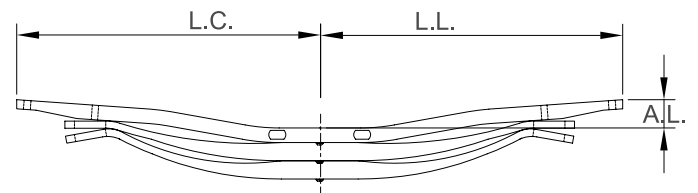
- Aplicación: 3 Leaf T-Ride Spring
- Capacidad: 46000 lb
- #Original: 8060822



ANCHO	# HOJAS	CALIBRE	ARCO LIBRE	LONGITUD LADO CORTO	LONGITUD LADO LARGO	BUJE LADO CORTO	BUJE LADO LARGO	PUNTA LADO CORTO	PUNTA LADO LARGO
3 1/2	3 / 1.5, 1.89	1.5	2 15/16	31 7/8	31 7/8	-	-	 13	13 

KA96-952

VOLVO

Muelle Delantera

- Aplicación: 8 Leaf Spring
- Capacidad: 9500 lb

#Original: 371010035

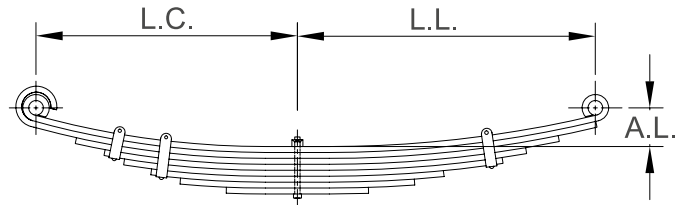

ANCHO	# HOJAS	CALIBRE	ARCO LIBRE	LONGITUD LADO CORTO	LONGITUD LADO LARGO	BUJE LADO CORTO	BUJE LADO LARGO	PUNTA LADO CORTO	PUNTA LADO LARGO
4	8/.558, .499	-	3 7/8	26 1/4	26 1/4	PLK	PLK	1	1

KA96-898

VOLVO

Muelle Delantera

- Aplicación: 8 Leaf Spring
- Capacidad: 9500 lb

#Original: 371010035

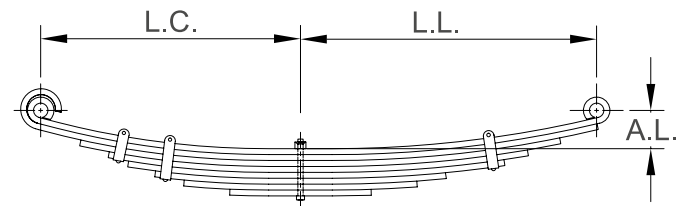

ANCHO	# HOJAS	CALIBRE	ARCO LIBRE	LONGITUD LADO CORTO	LONGITUD LADO LARGO	BUJE LADO CORTO	BUJE LADO LARGO	PUNTA LADO CORTO	PUNTA LADO LARGO
4	8/.558, .499	-	3 7/8	26 1/4	26 1/4	PLK	PLK	1	1

KA96-840

VOLVO

Muelle Delantera

- Aplicación: Volvo Spring 4x499" 8lvs
- Capacidad: 8500 lb

#Original: 371010007

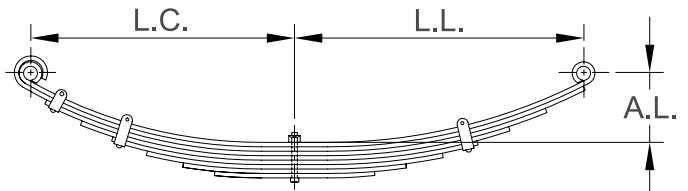

ANCHO	# HOJAS	CALIBRE	ARCO LIBRE	LONGITUD LADO CORTO	LONGITUD LADO LARGO	BUJE LADO CORTO	BUJE LADO LARGO	PUNTA LADO CORTO	PUNTA LADO LARGO
4	8/.499	.499	4 1/2	26	26	PLK	PLK	1	1

KA96-184-P

VOLVO

Muelle Delantera

- Aplicación: 3 Leaf Auto Hauler Spring
- Capacidad: 5500 lb

#Original: 371010089

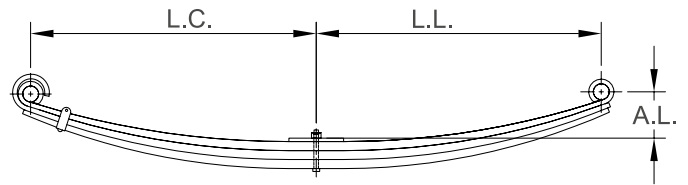

ANCHO	# HOJAS	CALIBRE	ARCO LIBRE	LONGITUD LADO CORTO	LONGITUD LADO LARGO	BUJE LADO CORTO	BUJE LADO LARGO	PUNTA LADO CORTO	PUNTA LADO LARGO
4	3/.788	.788	3 5/8	25 1/2	25 1/2	PLK	PLK	1	1
	1A	.788	3 5/8	25 1/2	25 1/2	PLK	PLK	1	1
	2A	.788	3 5/8	25 1/2	25 1/2	-	-	4	9
	3A	.788	3 5/8	25 1/2	25 1/2	-	-	9	9

KA96-150A

VOLVO

Muelle Delantera

- Aplicación: 3 Leaf Taper With Inserts

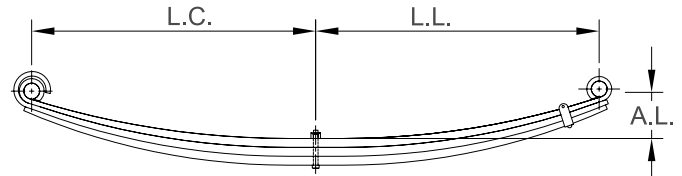

ANCHO	# HOJAS	CALIBRE	ARCO LIBRE	LONGITUD LADO CORTO	LONGITUD LADO LARGO	BUJE LADO CORTO	BUJE LADO LARGO	PUNTA LADO CORTO	PUNTA LADO LARGO
4	3 / .788	.788	6	26	26	PKL	PKL	1	1
	1A	.788	6	26	26	PKL	PKL	1	1
	2A	.788	6	26	26	-	-	4	9
	3A	.788	6	27	27	-	-	9	9

KA96-150A

VOLVO

Muelle Delantera

- Aplicación: 3 Leaf Taper With Inserts #Original: 371013201
- Capacidad: 5500 lb

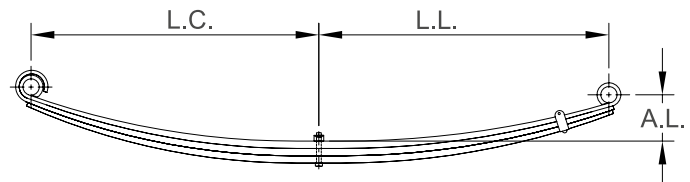

ANCHO	# HOJAS	CALIBRE	ARCO LIBRE	LONGITUD LADO CORTO	LONGITUD LADO LARGO	BUJE LADO CORTO	BUJE LADO LARGO	PUNTA LADO CORTO	PUNTA LADO LARGO
4	3 / .625	.625	6	26	26	PLK	PLK	1	1
	1A	.625	6	26	26	PLK	PLK	1	1
	2A	.625	6	26	26	-	-	4	9
	3A	.625	6	27	27	-	-	9	9

KATRA-3508

WATSON & CHALIN

Muelle Delantera

- Aplicación: Watson & Chalin #Original: SP-0060-0S

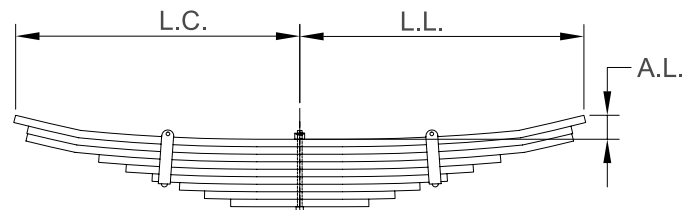

ANCHO	# HOJAS	CALIBRE	ARCO LIBRE	LONGITUD LADO CORTO	LONGITUD LADO LARGO	BUJE LADO CORTO	BUJE LADO LARGO	PUNTA LADO CORTO	PUNTA LADO LARGO
5	9 / .788	.788	13/4	30 1/8	30 1/8	-	-	13	13
	1A	.788	13/4	30 1/8	30 1/8	-	-	13	13
	2A	.788	13/4	29 5/8	29 5/8	-	-	21	21
	3A	.788	13/4	21 1/8	21 1/8	-	-	21	21
	4A	.788	13/4	18 1/4	18 1/4	-	-	21	21
	5A	.788	13/4	15 1/2	15 1/2	-	-	13	13
	6A	.788	13/4	12 5/8	12 5/8	-	-	21	21
	7A	.788	13/4	10	10	-	-	21	21
	8A	.788	13/4	7 1/4	7 1/4	-	-	21	21



KA96-1261

WHITE

Muelle Zeta

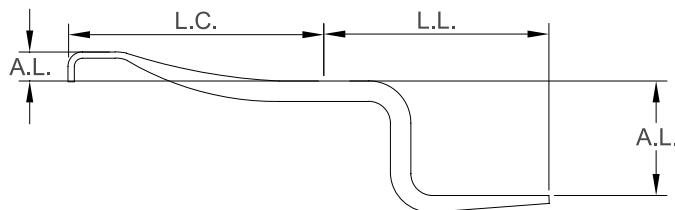
- Aplicación: Volvo Z-Beam Spring #Original: 8180246
- Capacidad: 10000 lb



ANCHO	# HOJAS	CALIBRE	ARCO LIBRE	LONGITUD LADO CORTO	LONGITUD LADO LARGO	BUJE LADO CORTO	BUJE LADO LARGO	PUNTA LADO CORTO	PUNTA LADO LARGO
3	1 / 1.750	1.750	ESPECIAL	24 1/8	18 1/8	-	-	 11	16 

KA96-103

WHITE

Muelle Zeta

- Aplicación: Volvo Z-Beam Spring #Original: 35003-3202
- Modelo: 72-83
- Capacidad: 10000 lb

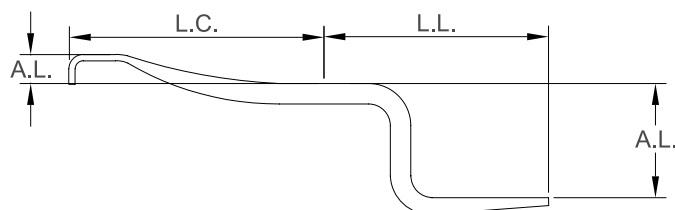

ANCHO	# HOJAS	CALIBRE	ARCO LIBRE	LONGITUD LADO CORTO	LONGITUD LADO LARGO	BUJE LADO CORTO	BUJE LADO LARGO	PUNTA LADO CORTO	PUNTA LADO LARGO
3	1 / 1.750	1.750	ESPECIAL	23 5/8	18 3/8	-	-	 11	16 

KA70-182

WHITE

Muelle Delantera

- Aplicación: Tractocamión #Original: 55-0828
- Modelo: 72-83 #Rassini: 70-182

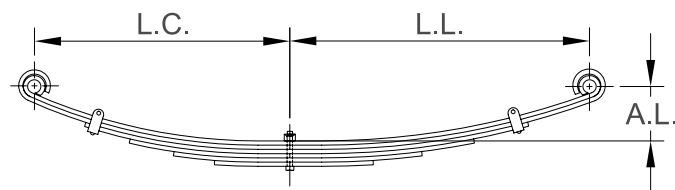

ANCHO	# HOJAS	CALIBRE	ARCO LIBRE	LONGITUD LADO CORTO	LONGITUD LADO LARGO	BUJE LADO CORTO	BUJE LADO LARGO	PUNTA LADO CORTO	PUNTA LADO LARGO
4	6 / .401	.401	6 1/8	26 1/4	26 1/4	NJK	NJK	 1	1 
	1A	.401	6 1/8	26 1/4	26 1/4	NJK	NJK	 1	1 
	2A	.401	6 1/8	26 1/4	26 1/4	-	-	 4	5 

BUJES DE BRONCE

NO. PARTE	DIÁMETRO EXTERIOR	DIÁMETRO INTERIOR	LARGO
BBVK	2-1/8	1-3/4	4
FCB	3/4	9/16	1-3/4
HDC	7/8	5/8	2
JFC	1	3/4	2
JFD	1	3/4	2-1/4
JFE	1	3/4	2-1/2
JFG	1	3/4	3
LHE	1-1/8	7/8	2-1/2
LHG	1-1/8	7/8	3
NHE	1-1/4	7/8	2-1/2
NHG	1-1/4	7/8	3
NJC	1-1/4	1	2
NJD	1-1/4	1	2-1/4
NJE	1-1/4	1	2-1/2
NJG	1-1/4	1	3
NJI	1-1/4	1	3-1/2
NJK	1-1/4	1	4
OJG	1-5/16	1	3
OLG	1-5/16	1-1/8	3
PJG	1-3/8	1	3
PJI	1-3/8	1	3-1/2
PLE	1-3/8	1-1/8	2-1/2
PLG	1-3/8	1-1/8	3
PLI	1-3/8	1-1/8	3-1/2
PLK	1-3/8	1-1/8	4
QLG	1-7/16	1-1/8	3
QLI	1-7/16	1-1/8	3-1/2
RFC	1-1/2	3/4	2
RLC	1-1/2	1-1/8	2
RNE	1-1/2	1-1/4	2-1/2
RNG	1-1/2	1-1/4	3

NO. PARTE	DIÁMETRO EXTERIOR	DIÁMETRO INTERIOR	LARGO
RNI	1-1/2	1-1/4	3-1/2
RNK	1-1/2	1-1/4	4
SMK	1-9/16	1-3/16	4
SNG	1-9/16	1-1/4	3
SNK	1-9/16	1-1/4	4
TNG	1-5/8	1-1/4	3
TNI	1-5/8	1-1/4	3-1/2
TNK	1-5/8	1-1/4	4
TOO	1-5/8	1-5/16	5
TPG	1-5/8	1-3/8	3
TPI	1-5/8	1-3/8	3-1/2
TPK	1-5/8	1-3/8	4
UQG	1-11/16	1-7/16	3
UOK	1-11/16	1-5/16	4
UQK	1-11/16	1-7/16	4
VNO	1-3/4	1-1/4	5
VPE	1-3/4	1-3/8	2-1/2
VPK	1-3/4	1-3/8	4
VPO	1-3/4	1-3/8	5
VRG	1-3/4	1-1/2	3
VRK	1-3/4	1-1/2	4
WSI	1-13/16	1-9/16	3-1/2
XRE	1-7/8	1-1/2	2-1/2
XRG	1-7/8	1-1/2	3
XRI	1-7/8	1-1/2	3-1/2
XRK	1-7/8	1-1/2	4
XSI	1-7/8	1-9/16	3-1/2
XTG	1-7/8	1-5/8	3
ZVG	2	1-3/4	3
ZVI	2	1-3/4	3-1/2

BUJES DE BRONCE

NO. PARTE	DIÁMETRO EXTERIOR	DIÁMETRO INTERIOR	LARGO
BBVK	2-1/8	1-3/4	4
FCB	3/4	9/16	1-3/4
HDC	7/8	5/8	2
JFC	1	3/4	2
JFD	1	3/4	2-1/4
JFE	1	3/4	2-1/2
JFG	1	3/4	3
LHE	1-1/8	7/8	2-1/2
LHG	1-1/8	7/8	3
NHE	1-1/4	7/8	2-1/2
NHG	1-1/4	7/8	3
NJC	1-1/4	1	2
NJD	1-1/4	1	2-1/4
NJE	1-1/4	1	2-1/2
NJG	1-1/4	1	3
NJI	1-1/4	1	3-1/2
NJK	1-1/4	1	4
OJG	1-5/16	1	3
OLG	1-5/16	1-1/8	3
PJG	1-3/8	1	3
PJI	1-3/8	1	3-1/2
PLE	1-3/8	1-1/8	2-1/2
PLG	1-3/8	1-1/8	3
PLI	1-3/8	1-1/8	3-1/2
PLK	1-3/8	1-1/8	4
QLG	1-7/16	1-1/8	3
QLI	1-7/16	1-1/8	3-1/2
RFC	1-1/2	3/4	2
RLC	1-1/2	1-1/8	2
RNE	1-1/2	1-1/4	2-1/2
RNG	1-1/2	1-1/4	3

NO. PARTE	DIÁMETRO EXTERIOR	DIÁMETRO INTERIOR	LARGO
RNI	1-1/2	1-1/4	3-1/2
RNK	1-1/2	1-1/4	4
SMK	1-9/16	1-3/16	4
SNG	1-9/16	1-1/4	3
SNK	1-9/16	1-1/4	4
TNG	1-5/8	1-1/4	3
TNI	1-5/8	1-1/4	3-1/2
TNK	1-5/8	1-1/4	4
T00	1-5/8	1-5/16	5
TPG	1-5/8	1-3/8	3
TPI	1-5/8	1-3/8	3-1/2
TPK	1-5/8	1-3/8	4
UQG	1-11/16	1-7/16	3
UOK	1-11/16	1-5/16	4
UQK	1-11/16	1-7/16	4
VNO	1-3/4	1-1/4	5
VPE	1-3/4	1-3/8	2-1/2
VPK	1-3/4	1-3/8	4
VPO	1-3/4	1-3/8	5
VRG	1-3/4	1-1/2	3
VRK	1-3/4	1-1/2	4
WSI	1-13/16	1-9/16	3-1/2
XRE	1-7/8	1-1/2	2-1/2
XRG	1-7/8	1-1/2	3
XRI	1-7/8	1-1/2	3-1/2
XRK	1-7/8	1-1/2	4
XSI	1-7/8	1-9/16	3-1/2
XTG	1-7/8	1-5/8	3
ZVG	2	1-3/4	3
ZVI	2	1-3/4	3-1/2

BUJES DE HULE METAL

NO. PARTE	DIÁMETRO EXTERIOR	LARGO DEL TUBO INTERNO	LARGO DEL CASQUILLO	DIÁMETRO INTERIOR
RB1	1-9/32	2-5/16	2	5/8
RB2	1-11/32		2	
RB3	1-1/2	2-3/4	2-1/4	3/4
RB4	1-13/32		2-1/4	
RB5	1-13/32		2-1/2	
RB6	1-9/16	3	2-3/4	3/4
RB7	1-5/32	2-3/8	2	1/2
RB8	1-5/32	3	2-1/2	3/4
RB9	1-1/2	3	2-1/2	1/2
RB11	1-7/32	2-1/8	1-3/4	9/16
RB12	7/8	3-1/2	1-3/4	3/8
RB13	7/8	4	2-1/4	3/8
RB14	1-1/2		2	
RB15	01-1/2		2-1/4	
RB18	3/4	3-3/4	2	3/8
RB19	3/4	4	2-1/4	3/8
RB20	1-1/8	4-1/2	2-1/4	9-16
RB21	1-5/16	2-3/4	2-1/4	9/16
RB22	1		1-3/4	
RB23	1-5/8	3	2-1/2	3/4
RB24	1-1/8	4	2	9/16
RB25	1-1/8	4-1/4	2-1/4	9/16
RB26	1-7/16	2-5/8	2-1/4	5/8
RB27	1	4	1-3/4	7/16
RB28	1-5/8	6	3	3/4
RB29	1-1/8		3	
RB30	7/8	2	1-3/4	7/16
RB31	7/8	3-1/4	2	
RB32	7/8	2-1/4	2	7/16
RB33	7/8	2-7/8	2-1/2	7/16

NO. PARTE	DIÁMETRO EXTERIOR	LARGO DEL TUBO INTERNO	LARGO DEL CASQUILLO	DIÁMETRO INTERIOR
RB34	1-1/4	2-7/8	2-1/2	5/8
RB35	1	2-5/16	2	1/2
RB36	1-1/8	2-7/8	2-1/2	5/8
RB37	7/8	1-13/16	1-3/4	7/16
RB38	7/8	2	1-3/4	7/16
RB39	1-3/8	2-5/16	2	1/2
RB40	1-1/2	2-7/8	2-1/2	5/8
RB41	1-1/8	2-9/16	2	1/2
RB42	1-3/8	2-7/8	2-1/2	7/16
RB43	1-3/8	3	2-1/2	1/2
RB44	7/8	2-1/4	2	7/16
RB45	7/8	2 1/2	2	7/16
RB46	1-1/2	3	2-1/2	7/16
RB47	1-3/8	2-1/2	2	7/16
RB48	1	3	2-1/2	1/2
RB49	1-1/8	3-1/4	2	
RB50	1	2-1/2	2	7/16
RB51	1-1/4	2-5/8	2	5/8
RB52	1-1/8	2-3/4	2-1/4	9/16
RB53	1	2-1/8	2	7/16
RB54	1-1/8	2-5/16	2	5/8
RB55	7/8	3-1/8	2-1/2	7/16
RB56	1	2-5/16	2	1/2
RB57	1	2-7/8	2-1/2	1/2
RB58	1-1/2	2-7/8	2-1/2	3/4
RB59	1-1/2	3	2-1/2	7/16
RB60	2	3-1/8	2-1/2	5/8
RB61	1-1/8	2-1/2	2	9/16
RB62	1-3/8	3-3/8	3	11/16
RB63	2-1/8	4-3/8	4	1

NO. PARTE	DIÁMETRO EXTERIOR	LARGO DEL TUBO INTERNO	LARGO DEL CASQUILLO	DIÁMETRO INTERIOR
RB64	1-3/8	3	2-1/2	7/16
RB65	2	2-3/4	2-1/4	9/16
RB66	1-1/8	2-1/2	2-3/16	9/16
RB67	2	2-1/2	2-1/4	9/16
RB68	7/8	1-7/8	1-3/4	7/16
RB69	2	2-1/2	2	1/2
RB70	1-1/4	2-3/4	2-1/4	5/8
RB71	1-1/2	2-3/4	2-1/2	9/16
RB72	1-1/2	2-3/4	2-1/2	3/4
RB73	1-11/16	3-1/4	3	15/16
RB74	1-3/8	2-3/4	2-1/2	5/8
RB75	1-13/16	3-1/4	3	1
RB76	1-1/4	2-9/16	2-1/2	9/16
RB77	1-3/4	2-3/4	2-1/2	9/16
RB78	1-1/2	2-1/16	1-15/16	7/8
RB79	1-3/4	2-3/16	1-15/16	9/16
RB80	1-1/2	2-5/8	2-1/2	7/8
RB81	1-1/4	2-7/8	2-1/2	5/8
RB82	2-1/16	3	2-1/2	1/2
RB83	2	3-1/4	2-1/2	5/8
RB84	2-1/2	4-1/4	4	1-1/4
RB85	1-1/4	2-11/16	2-1/2	9/16
RB86	1-1/2	2-3/16	1-15/16	7/8
RB87	1-1/2	2-3/4	2-1/2	7/8
RB88	1-1/2	2-5/8	2	9/16
RB89	1-3/8	2-1/2	2	9/16
RB90	2	2-3/4	2-1/2	3/4
RB91	1-1/2	3-1/8	2-1/2	5/8
RB92	1-1/8	2-5/8	2	9/16
RB93	1-5/8	2-5/8	2	9/16
RB94	1-7/8X2-1/4	3-1/4	3	15/16
RB95	2	3-3/4	3	1/2
RB96	2	3-3/4	3	1/2

NO. PARTE	DIÁMETRO EXTERIOR	LARGO DEL TUBO INTERNO	LARGO DEL CASQUILLO	DIÁMETRO INTERIOR
RB97	1-1/2	3-1/2	3	1/2
RB98	1-1/2	3-1/2	3	9/16
RB99	1-1/8	3-1/2	3	1/2
RB100	1-11/16	2-3/4	2-1/2	3/4
RB101	1-1/4	2-3/4	2-1/2	5/8
RB102	1-1/4	3-3/8	3	9/16
RB103	2-1/2	3-3/8	2-1/2	5/8
RB104	1-5/8	2-3/4	2-1/2	7/8
RB105	1-3/4	3-5/16	3	15/16
RB106	2-1/16	2-3/8	1-3/4	1/2
RB107	1-1/2	2-3/8	1-3/4	1/2
RB108	2-1/16	3-1/16	2-1/2	1/2
RB109	1-1/2	3-1/8	2-1/2	1/2
RB110	1-3/8	2-3/4	2-1/2	9/16
RB111	1-1/2	2-7/8	2-1/2	5/8
RB112	1-1/8	2-7/8	2-1/2	1/2
RB113	1-3/8	3	2-1/2	9/16
RB114	1-1/2	3-1/8	2-1/2	9/16
RB115	1-3/16	2	1-3/4	7/16
RB116	1-13/16	3-1/4	3	7/8
RB117	1-1/2	3	2-1/2	9/16
RB118	1-1/4	2-3/4	2	9/16
RB119	1-1/2	2-3/8	1-15/16	1/2
RB120	1-1/4	2-3/4	2-1/2	9/16
RB121	2	3-1/8	2-1/2	9/16
RB122	2-3/8	5-5/16	5	1
RB123	1-3/4	2-3/4	2-1/2	1
RB124	1-9/32	2-7/8	2-1/2	5/8
RB125	1-7/8	2-5/8	2	7/16
RB126	1-7/8	2-9/16	2	3/8
RB127	1-3/16	2-1/4	2	7/16
RB128	1-1/2	2-3/4	2-1/2	9/16
RB129	1-3/4	3	2-1/2	5/8

NO. PARTE	DIÁMETRO EXTERIOR	LARGO DEL TUBO INTERNO	LARGO DEL CASQUILLO	DIÁMETRO INTERIOR
RB130	2	2-3/4	2-1/2	9/16
RB131	1-1/4	3	2-9/16	9/16
RB132	1-3/8	3-1/2	3-1/16	5/8
RB133	1-1/4	3-1/2	3-1/16	9/16
RB134	1-1/2	3-1/4	3	5/8
RB135	1-3/4	3-1/2	3	3/4
RB136	1-3/4	3	2-1/2	9/16
RB137	1-1/2	3-3/8	3	9/16
RB138	1-3/4	2-3/4	2-1/2	9/16
RB139	2X3	3-1/4	2-1/2	9/16
RB140	1-1/4	2-7/8	2-1/2	9/16
RB141	1-3/4	2-7/8	2-1/2	1
RB142	7/8	2-1/16	1-3/4	7/16
RB143	2X3	3-1/8	2-1/2	5/8
RB144	1-1/2	2-7/8	2	9/16
RB145	1-1/2	2-7/8	2-1/2	9/16
RB146	1-3/4	3-5/16	3	7/8
RB147	2X3	3-1/16	2-1/2	1/2
RB148	1-5/8	3-3/8	3	5/8
RB149	1-3/8	3-3/8	3	9/16
RB150	2X3	3-1/8	2-1/2	9/16
RB151	1-1/2	3-1/2	3-1/16	5/8
RB152	1-3/8	3-1/2	3-1/16	9/16
RB153	2	2-15/16	2-1/2	9/16
RB154	2-1/4	3-1/8		3/4
RB155	2	3-1/2	3	9/16
RB156	1-9/32	2-3/4	2-1/2	5/8
RB157	1-3/8	3-1/2	3-1/16	9/16
RB158	1-5/8	3-1/2	3-1/16	5/8
RB159	1-5/8	3	2-1/2	9/16
RB160	1-1/4	3	2-1/2	9/16
RB161	1-3/4	7	4	1
RB162	2-1/2	4-1/4	4	7/8
RB163	2-1/2	3-1/8	2-1/2	9/16

NO. PARTE	DIÁMETRO EXTERIOR	LARGO DEL TUBO INTERNO	LARGO DEL CASQUILLO	DIÁMETRO INTERIOR
RB164	2-9/16	5-3/4	2-3/16	1-1/8X1-1/2
RB165	48 MM	100 MM	99 MM	24 MM
RB166	48 MM	183 MM	99 MM	27 MM
RB167	2-3/8	3-1/8	3	7/8
RB168	3	3-1/4	3	1-3/4
RB169	2-1/2	3-3/16	2-5/8	9/16
RB170	1-1/2	2-7/8	2-1/2	9/16
RB171	2X3	3-1/4	2-1/2	9/16
RB172	1-11/16	3	2-5/8	9/16
RB173	42 MM	80 MM	70 MM	16 MM
RB174	2-1/2	3-3/4	4	1
RB175	1-3/4	6-3/4	4	3/4X1-3/16
RB176	2	3-1/2	3	5/8
RB177	1-13/16	3-1/2	3	3/4
RB178	1-5/8	3-1/2	3	5/8
RB179	2	4-1/2	4	9/16
RB180	2	4-1/2	4	5/8
RB181	1-13/16	4-1/2	4	13/16
RB182	1-5/8	4-1/2	4	5/8
RB183	40 MM	40 MM	34 MM	16 MM
RB184	51 MM	179 MM	100 MM	32 MM
RB185	2-5/8	8	5	1X1-7/16
RB186	40 MM	41 MM	34 MM	16 MM
RB187	2-1/2	4-1/4	4	1
RB188	48 MM	89 MM	87 MM	24 MM
RB189	48 MM	171 MM	87 MM	27 MM
RB190	46 MM	92 MM	89 MM	20 MM
RB191	52 MM	77 MM	74 MM	22 MM
RB192	40 MM	70 MM	60 MM	14 MM
RB193	45 MM	140 MM	80 MM	25 MM
RB194	50 MM/55 MM	95 MM		16 MM
RB195	55 MM /62MM	120 MM		20 MM
RB196	46 MM	161 MM	100 MM	25 MM
RB197	36 MM	80 MM	70 MM	14 MM

NO. PARTE	DIÁMETRO EXTERIOR	LARGO DEL TUBO INTERNO	LARGO DEL CASQUILLO	DIÁMETRO INTERIOR
RB198	37 MM	90 MM	77 MM	18 MM
RB199	2-1/2	6-3/4	4	7/8X1-1/2
RB200	1-3/4		3-1/2	
RB201	33 MM	70 MM	60 MM	12 MM
RB202	40 MM	70 MM	60 MM	18 MM
RB203	1-3/4	3-9/16	3	3/4
RB204	1-3/4	3-9/16	3	5/8
RB205	2-1/2	7-1/2	3	7/8X1-13/16
RB206	1-11/16	3	2-3/8	9/16
RB207	1-5/8	3	2-1/2	5/8
RB208	46 MM	150 MM	80 MM	25 MM
RB209	40 MM	70 MM	60 MM	14 MM
RB210	55 MM X 73 MM	80 MM	70 MM	14 MM
RB211	57 MM	108 MM	100 MM	21 MM
RB212	57 MM	108 MM	75 MM	21 MM
RB213	1-5/8	3-1/2		5/8
RB214	1-5/8	3-1/2		9/16
RB215	2-1/2	3		9/16
RB216	1-11/16	3		9/16
RB217	1-7/16	2-3/4	2-1/2	5/8
RB218	1-13/16	3-1/2	3	3/4
RB219	1-13/16	3-1/2	3	5/8
RB220	2	3-3/8	3	7/8
RB221	2-1/2	3-1/2	3-1/4	1
RB222	56 MM/60 MM	105 MM		19 MM
RB223	48 MM/53 MM	91 MM		16 MM
RB224	1-11/16	3		9/16
RB225	2-1/4	4-1/2		9/16
RB226	2-1/4	4-1/2		5/8
RB227	2	3-1/2	3-1/8	0.709
RB228	42 MM	81 MM	72 MM	16 MM
RB229	1-3/4	3-1/2	3-1/16	5/8
RB230	1-23/32	3-1/16	2-1/2	9/16
RB231	2	3	2-5/8	9/16

NO. PARTE	DIÁMETRO EXTERIOR	LARGO DEL TUBO INTERNO	LARGO DEL CASQUILLO	DIÁMETRO INTERIOR
RB232	2-5/8	5-5/16	5	1-1/4
RB233	2-1/4	4-1/4	4	3/4
RB234	2-1/2	7-1/2	3-3/16	7/8X1-13/16
RB235	1-3/4	3		0.709
RB236	1-3/8	3		0.551
RB237	1-7/8	3	2-1/2	9/16
RB238	52 MM	77 MM	74 MM	16 MM
RB239	46 MM	77 MM		14 MM
RB240	1-1/2	3	2-1/2	9/16
RB241	1-1/2	3	2-1/2	9/16
RB243	1-3/4	3-1/2		0.787
RB244	1-3/4	3-1/2		0.63
RB245	2-3/16	3-1/2		0.709
RB246	42 MM	80 MM	70 MM	18 MM
RB247	2-3/16	3-1/2		0.709
RB248	1-3/4	3-1/2		0.63
RB249	1-3/4	7-1/8	4-1/16	1-1/16
RB250	50 MM/55 MM	76 MM	63 MM	16 MM
RB251	1-1/2	3	2-1/2	9/16
RB252	40 MM	70 MM	60 MM	14 MM
RB253	1-13/16	4-1/4	4-1/16	3/4
RB255	1-1/2	3	2-5/8	9/16
RB256	2-1/4	3-1/4	3	3/4
RB257	1-1/2	3	2-1/2	9/16
RB258	1-13/16	3-1/4	3-1/16	3/4
RB259	2-9/16	5-3/4	2-5/8	1-1/8X1-1/2
RB260	40 MM	37 MM	30 MM	15 MM
RB261	1-7/8	3	2-1/2	9/16
RB262	2-3/32	4-3/16	3-1/2	15/32
RB263	2-1/4	6-7/8	4	1-1/4
RB264	1-13/16	4-1/2		5/8
RB265	2-1/2	3-3/8	3	1-1/4
RB266	2	3	2-5/8	9/16
RB267	45 MM	91MM	78MM	19MM

A close-up photograph of industrial machinery. A bright orange, glowing, curved metal part is being processed. In the foreground, there are several large, dark metal rollers or spools. The background is dark and industrial, with some blue cables visible.

74
AÑOS DE
EXPERIENCIA
NOS RESPALDAN





AVANZADA
TECNOLOGÍA
ALEMANA



SE MANTIENE COMO UNO
DE LOS LÍDERES
A NIVEL NACIONAL



ACEROS DE
IMPORTACIÓN
EUROPEA



KATAI

NUESTROS PUNTOS DE VENTA

DIREGO TIJUANA
(664) 607 9850

DIREGO SAN LUIS
(444) 830 5335

DIREGO CULIACÁN
(667) 147 3333

DIREGO HERMOSILLO
(662) 254 2698

DIREGO MANTE
(831) 232 6378

DIREGO MÉXICO
(55) 58 70 5115

DIREGO CHIHUAHUA
(614) 481 8483

DIREGO LEÓN
(477) 104 4794

DIREGO VICTORIA
(834) 316 7647

DIREGO TORREÓN
(871) 744 0633

DIREGO TUXTLA
(961) 118 3695

DIREGO VILLAHERMOSA
(993) 142 7149

DIREGO SALTILLO
(844) 415 2839

DIREGO PUEBLA
(222) 249 4383

DIREGO GUADALAJARA
(33) 3837 0410

DIREGO MONTERREY
(81) 81 26 1500

DIREGO VERACRUZ
(229) 924 5545

DIREGO POZA RICA
(782) 826 8320

DIREGO ESCOBEDO
(81) 35 41 4990

DIREGO OAXACA
(951) 688 2660

DIREGO MANZANILLO
PRÓXIMAMENTE

DIREGO VALLES
(481) 383 2236

DIREGO QUERÉTARO
(442) 277 4531

DIREGO CALI COL.
+57 (2) 669 3939

DIREGO TAMPICO
(833) 230 3500

DIREGO MÉRIDA
(999) 946 2988

DIREGO BOGOTÁ COL.
+57 (1) 927 9695